

Proceedings of the Danish Institute at Athens IV

Edited by Jonas Eiring and Jørgen Mejer



© Copyright The Danish Institute at Athens, Athens 2004

The publication was sponsored by:
The Danish Research Council for the Humanities
Generalkonsul Gösta Enboms Fond.

Proceedings of the Danish Institute at Athens

General Editors: Jonas Eiring and Jørgen Mejer.
Graphic design and production: George Geroulis, Press Line.

Printed in Greece on permanent paper.

ISBN: 87 7288 724 9

Distributed by:
AARHUS UNIVERSITY PRESS
Langelandsgade 177
DK-8200 Århus N
Fax (+45) 8942 5380

73 Lime Walk
Headington, Oxford OX3 7AD
Fax (+44) 865 750 079

Box 511
Oakvill, Conn. 06779
Fax (+1) 203 945 94 9468

Cover illustration: Finds from the Hellenistic grave at Chalkis, Aetolia.
Photograph by Henrik Frost.

Death in Aetolia. The Hellenistic Graves at Aetolian Chalkis

Jonas Eiring
with contributions by
Georgia
Z. Alexopoulou
and Marie Lousie
S. Jørkov

Introduction

The preliminary survey in 1995 and the following seven excavation campaigns at Aetolian Chalkis were primarily concerned with the settlement on the hill of Hagia Triada, while the cemeteries in the surrounding area have remained largely unexplored.¹ The existence of graves in the general area has however been known for a long time, particularly due to grave robbing. Two graves were discovered immediately north of the hill in 1998, during works for a new water supply system in the village of Kato Vasiliki and published by Ioannis Moschos in the second preliminary report of the Chalkis project.²

Both were cist graves: one (GR1) was found empty, whereas the second grave (GR2) contained a wine-jug, a small echinus bowl, a plate, a skyphos, a miniature vase, a lamp and a silver ring, as well as one, disturbed but – bar the

left hand – complete skeleton. The burial was dated by the pottery assemblage in the late fourth or early third century B.C. The pottery from GR2 is well illustrated in the report by Moschos.

The year following the discovery of GR1 and GR2, two further graves were found and excavated beneath the western slope of the Hagia Triada hill. Geological examinations had indicated that this area, a sedimentary plain at the mouth of the river, would be the likely site for the ancient harbour. Rather than harbour installations, the remains so far unearthed have revealed a settlement on the lower slopes, with vestiges at least from the Early Iron Age (Figs. 1-2).³

The four excavated trenches, K26-29, cover only a small area of the lower slope, but it is clear that the settlement here was abandoned in the Archaic period, since there is no evidence of any

¹ I would like to thank, first and foremost, the technicians and students, who have worked with much dedication on the successive campaigns at Kato Vasiliki and I am indebted to the project's directors, Dr. phil. Søren Dietz and Dr. Lazaros Kolonas, Director General of the Archaeological Service. Dr. Michail Petropoulos, Director of the 6th Ephorate of Antiquities at Patras and his entire staff have facilitated our work in every way. I would like to express my particular gratitude to Sanne Houbby-Nielsen, Ioannis Moschos, Elizabeth Bollen, Hans Henrik Frost, Anne Hooton and Georgia Alexopoulou. My work would not have been possible without generous financial support from the *Generalkonsul Gösta Enboms Fond*.

² I. Moschos in *SPR*, 291-301.

³ S. Houbby-Nielsen *et al.*, *TPR*.



Fig. 1. Graves GR3 (left) and GR4 after excavation, from E.

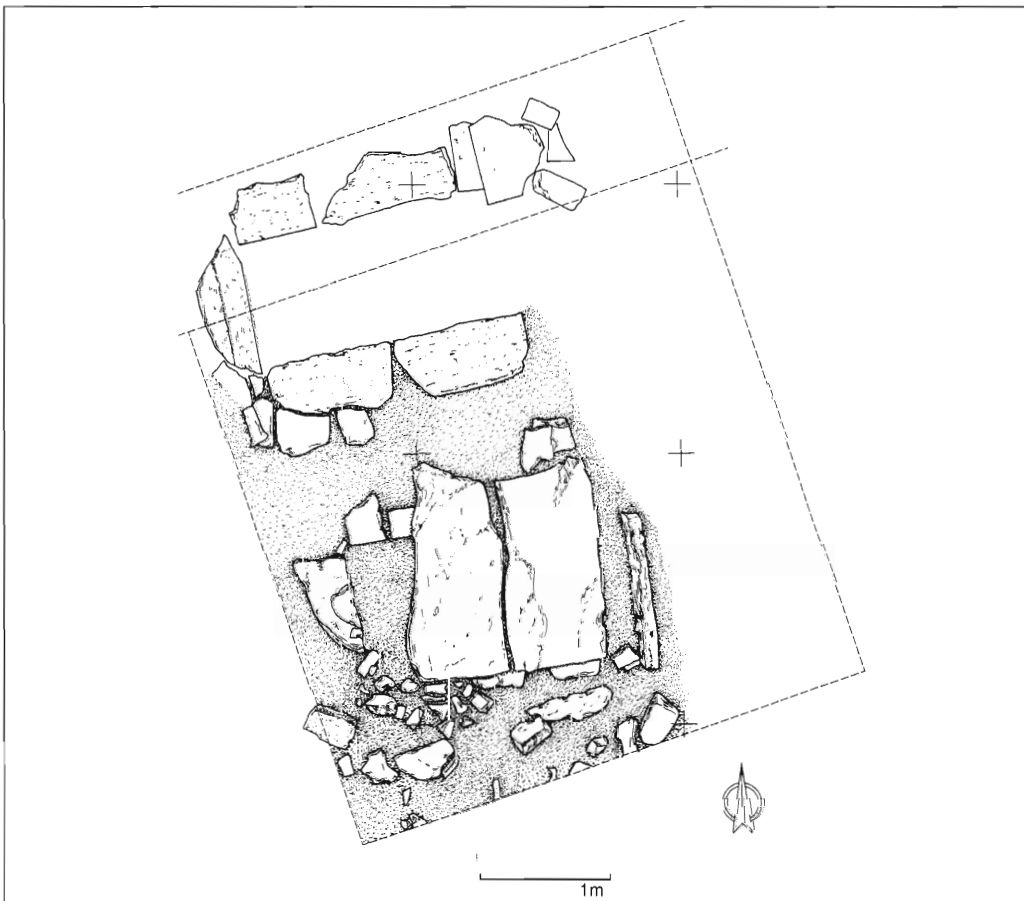

Fig. 2. Graves GR3 and GR4, the former with cover slabs. C. Marinopoulos.

Fig. 3. GR3 and GR4:
section.
C. Marinopoulos.

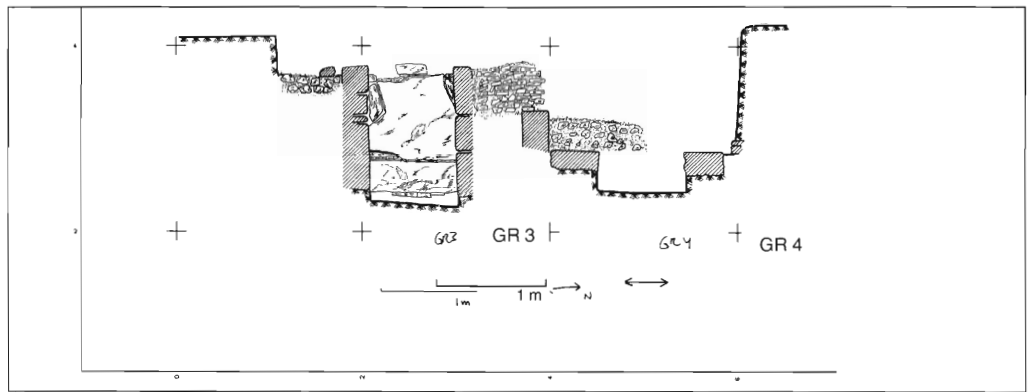
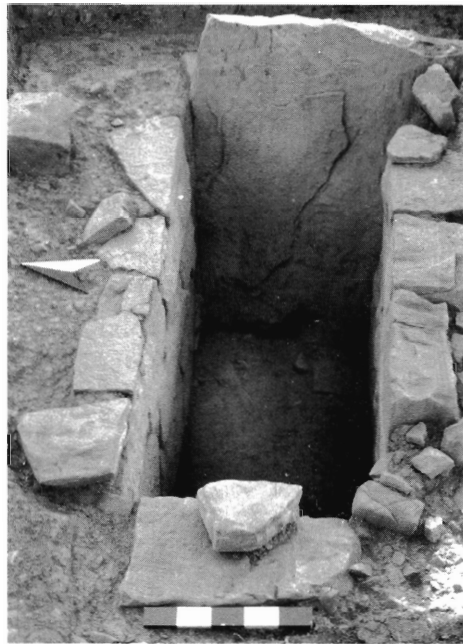

Fig. 4. GR3 after excavation.



later building activity, and that it gave way to a cemetery, established on top of the ruined houses, in Late Classical times. Two graves have been excavated, but there is every reason to believe that they were not the only ones in the area (Fig. 2-3). The grave GR3, datable by its finds in the Early Hellenistic period, is located in trench K26; GR4 bridges that and trial trench Tx71.

The existence of grave GR3 was suspected, but not immediately identified, when the upper edge of the ashlar blocks of the northern side of the structure first came to light in a trial trench (Tx70-74), which was opened on the

Fig. 5. GR3: plan of grave
after removal of cover slabs.
Drawing: A. Hooton.

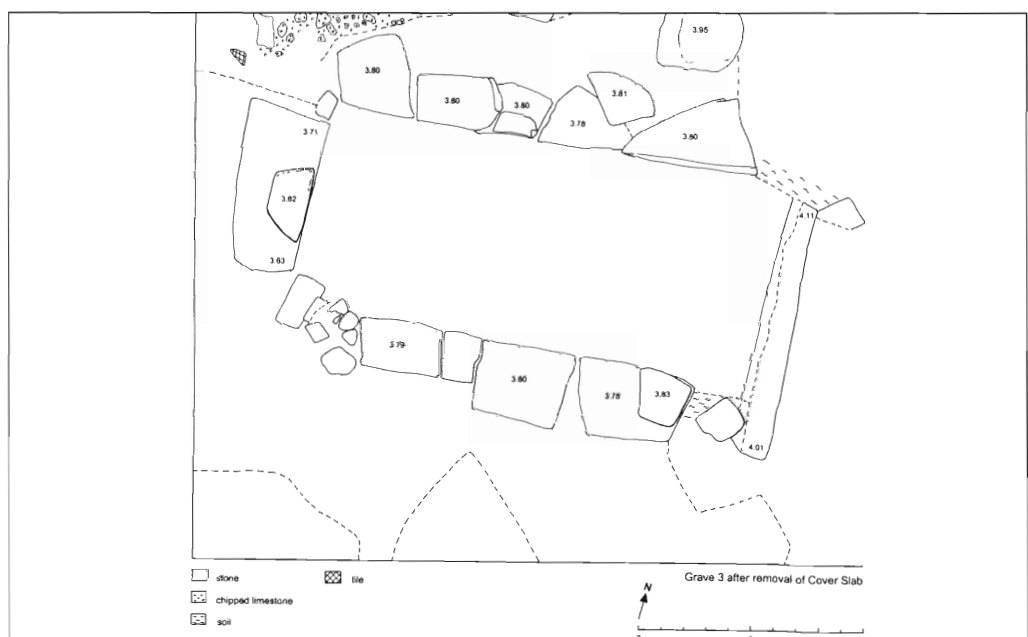



Fig. 6. GR3: burial D in situ, with burials A-C and grave goods in NW corner.

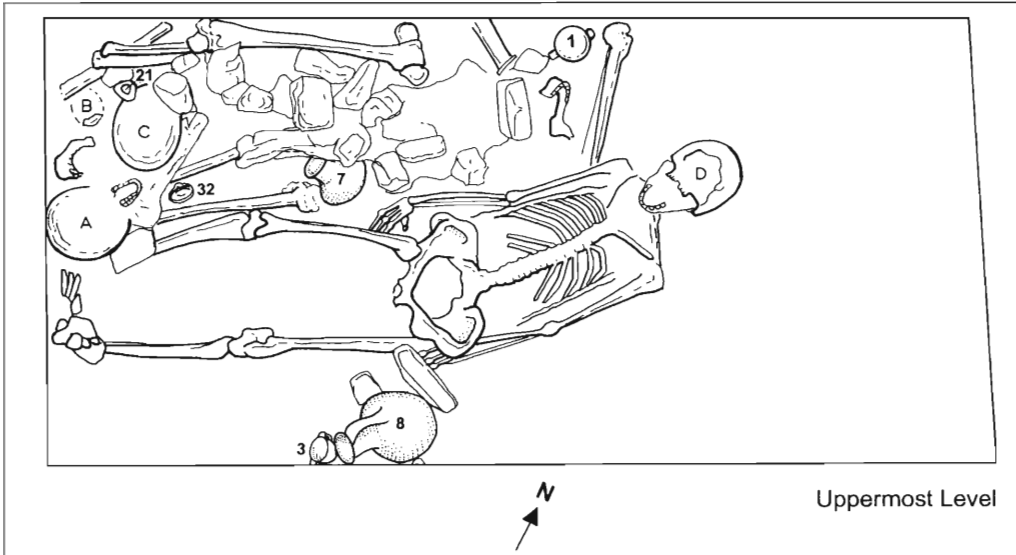

Fig. 7. GR3: contents uppermost level. Drawing: A. Hooton.

lower western slope in 1998.⁴ The following year the trial trench was widened into trench K26, and the grave excavated (Figs. 4-5). It was built of large well-cut limestone blocks, smoothed on the face towards the cist. The grave was oriented roughly west to east and its eastern end was formed by a very large, standing slab. The whole structure was covered by large slab

stones, two of which were found in situ over the eastern part. The western end was found uncovered, which led to initial suspicions of yet another robbed grave. As was later discovered, the inside of the grave had, however, been left untouched since Antiquity. The total internal length of the grave was 2.10 m, width 1 m, and depth, from the top to the last block on the side, 1.40 m.

⁴ S. Houby-Nielsen *et al.*, in *SPR*, 239, Figs. 22, 25; D. Blackman, *AR* 46 (2000), 41-42.

The state of preservation of the finds came, indeed, as a surprise and with the long and steadfast tradition of grave robbery in mind, it was decided to excavate as quickly as possible. It was done over two days and guard was kept by the whole team throughout the night. It would, of course, have been preferable to have more time at hand, since some ancillary information inevitably was lost due to the swift work.

GR4 was built in a very similar fashion to GR3. The two graves were nearly parallel, the latter being oriented slightly more towards NNW-SSE. As GR3, it was built of large, smoothed limestone blocks, although only the lowermost courses were preserved. The dimensions were marginally smaller than those of the neighbouring grave: length 1.90 m and width 96 cm. The grave was found empty.

The architecture is so similar in all four tombs, GR1-4, as to warrant a date in roughly the same period. The contents

of the GR2 and GR3 confirm that the excavated tombs should belong in the period covering the late fourth and early third centuries B.C.

The present article aims to describe the grave goods found in GR3 in some detail, but a more far-reaching analysis of the graves at Aetolian Chalkis will be presented in a planned study of the burial customs in Western Greece. The description of the grave goods is followed by an account of the skeletal remains by Marie Louise Jørkov. These include four burials: three, including an adult man, an adult woman, and a child, which had been pushed aside into the northwest corner of the grave, and the last burial (skeleton D), found in situ, being that of an adult woman (Fig. 6). The grave was dug in five strata, but the burials were all located in stratum 3. Although the soil did not change, the burials were dug in three levels, in order to give an idea how the different objects were found in relation to each other and to the bones (Figs. 7-10).

Fig. 8. GR3: contents level I.
Drawing: A. Hooton.

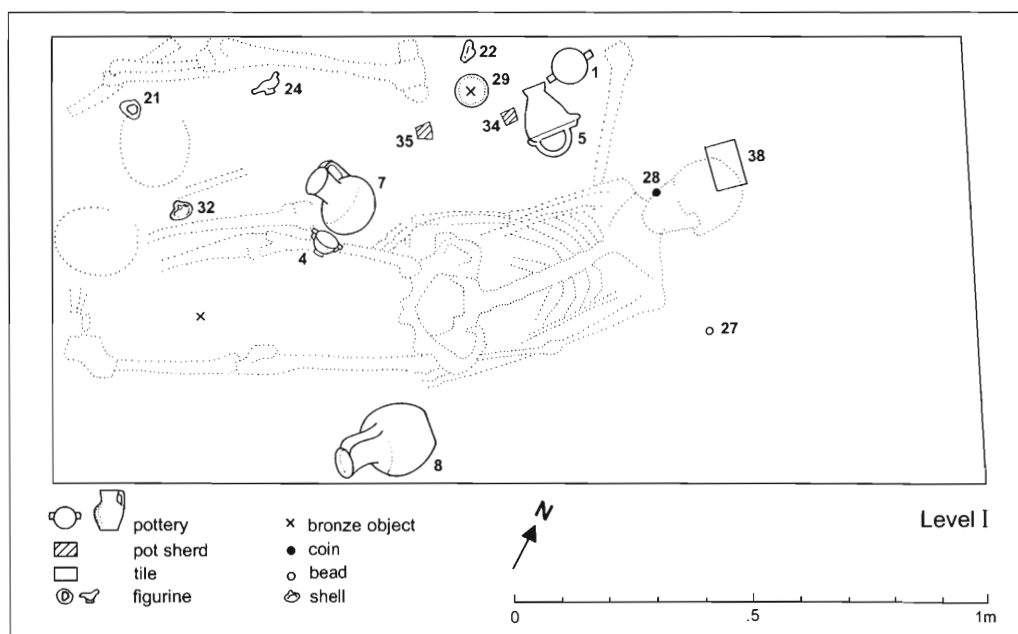

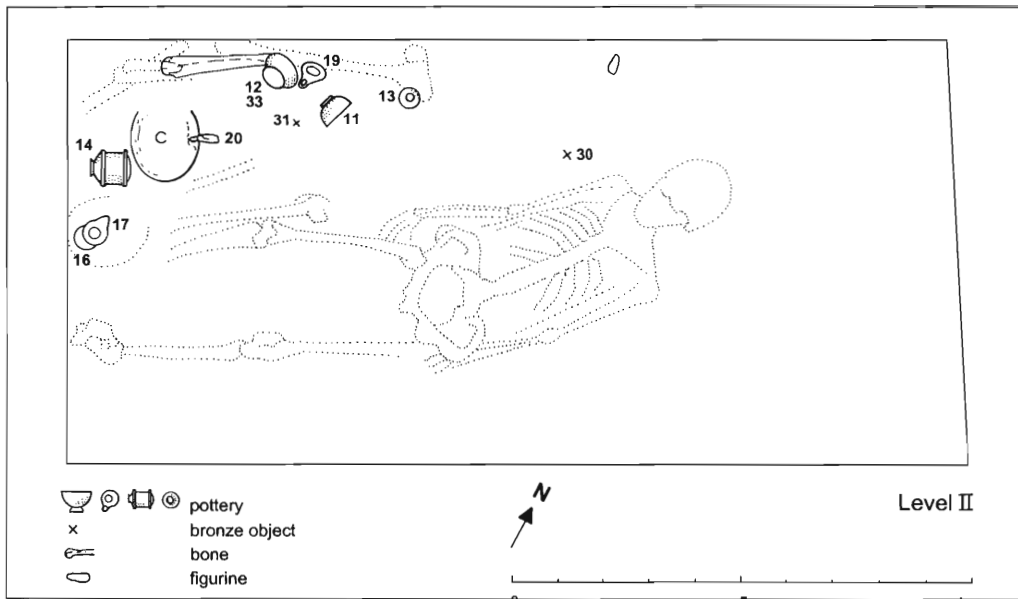

Fig. 9. GR3: contents level II
 Drawing: A. Hooton.

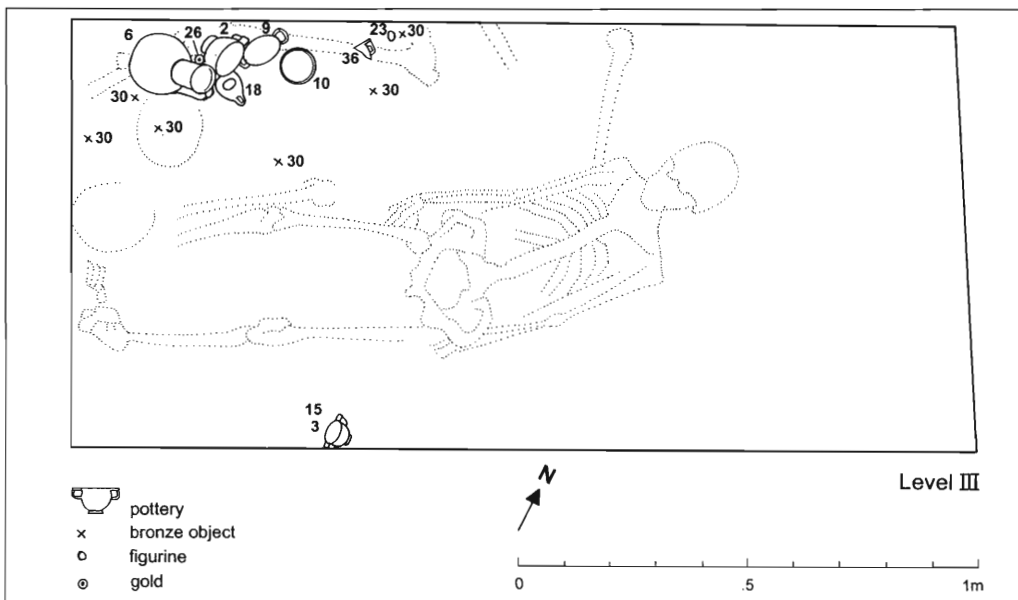

Fig. 10. GR3: contents level III
 Drawing: A. Hooton.

The Grave Goods

Seven years of archaeological exploration in and around the village of Kato Vasiliki have given us a good picture of the material evidence left behind by the erstwhile inhabitants of ancient Chalkis in Aetolia. The site was occupied for a very long time, as evidenced by the pottery, which covers most periods from Final Neolithic to Hellenistic. Later, after a hiatus in the Imperial Ro-

man period, the hill of Hagia Triada was once again occupied in Early Christian times. Judging by the volume of potsherds, one of the most prolific periods at the site was the transition from what we normally call Late Classical to Early Hellenistic, i.e. the late fourth and early third centuries B.C.

If the quantity of Hellenistic pottery is abundant, its quality, as usual in the Hellenistic period, is very uneven. Add

to that the acid soil in Aetolia, which has caused such severe damage to the pottery in the ground that the surface on Hellenistic sherds, coated in a slip with less adhesiveness than in earlier periods, is generally totally gone. We are left to examine the clay itself, which shows that pottery was brought to the site from several sources. No pottery workshop has so far been identified at the site, and no kiln located, although there is some evidence of misfired sherds, which could be rejects from pottery manufacture.

The main body of the assemblage from the site is much in line with western Greek, in particular Elican, pottery traditions, but there are clear affinities both with Corinth and Southern Italy. There is no imported Attic material after the late fourth century.

The pottery from the grave is typical of the site in general, and came from several sources. It is – obviously, since no kiln has been found – not possible to determine which vessels are of local production, and which come from other centres in the region. There is no evidence, in the grave assemblage, of pots from distant regions in the Greek world. A particularly interesting feature in the grave is that we seem to have, for the main types of pottery, the same number of vessels as we have burials, i.e. four. A very close parallel to our grave, both as regards the composition of the assemblage and the style of the pottery, is to be found in a grave at Trichonio, by the lake of the same name in inland Ae-

tolia. That grave was excavated in 1976 and recently published by Photeini Zaphiropoulou.⁵ The grave contained only one skeleton, accompanied by a kantharos, a jug, and a lamp, all remarkably similar to those found in our grave. The Trichonio grave will therefore be referred to in each of those cases.

The other single-burial grave, which should also be referred to, is the earlier mentioned grave, GR2, north of Chalkis. The equipment in that grave resembles that of GR3 in many ways.

All measurements, unless stated otherwise, are in centimetres. The following abbreviations are used: D: diameter; DB: diameter of base; DR: diameter of rim; H: height (on vessels distance from rim to base, excluding handle if higher than rim); L: length; T: thickness; W: width.

Drinking cups

φέρ' ὕδωρ, φέρ' οἶνον, ὦ παῖ·
μέθυσόν με καί κάρωσον·
τὸ ποτήριον λέγει μου
ποδαμόν με δεῖ γενέσθαι.⁶

Ancient Greek vessels for drinking occur in a variety of shapes, which can either have one or two handles, or be handle-less. The cup with two handles has sometimes been associated with drinking at the symposium, where the handles would have a practical function when the vessel was passed from one person to the next. It may be that practical aspects of communal drinking lies

⁵ *Trichonio*, 324, pl. 163α-γ.

⁶ *Anacreont.* 60B: “Bring water, bring wine, boy: make me drunk and stupefy me: my cup tells me what must become of me”.

behind the development of such a shape, although it would be stretching the evidence to claim that it grew out of the symposium as an institution. One should bear in mind that two-handle drinking vessels were current from the earliest pottery-making times and are general in many geographical settings.

Kantharoi

1. F99-5015. GR3/3. Kantharos containing four frs. of bones (animal vertebra). Restored from 11 sherds, fr. missing from rim and body. DR 6.9-7.2; DB 3.6; H 6.9. Fine, reddish yellow fabric (5YR 6/8). Good, thick and lustrous black gloss with slightly brown tinge and some red spots. Coated on all surfaces. Thin-walled vessel with convex profile and incurved rim. Narrow, vertical strap handles with thumb-rests: rectangular plates attached at top of handle. Belly undercut by tool resulting in carination. Splaying, narrow ring foot. Underside of floor raised at centre.

2. F99-5063. GR3/3. Kantharos containing miniature dove (see no. 25), four sherds and four fragmentary animal bones. Restored from 14 sherds, fragment missing from rim. DR 7.8; DB 4.3; H 9.9. Fine, quite hard, generally reddish buff fabric (7.5YR 7/6), but misfired to a mottled pink and grey in patches. Fugitive dark brownish-black gloss inside and out, and underfoot. Reserved resting surface. Straight wall profile with simple rim. Two vertical strap handles with thumb-rests. Three grooves under gloss on belly. Uneven pedestal foot with mouldings.

3. F99-5056. GR3/3. Kantharos containing miniature krateriskos (see no. 15). Restored from 12 sherds, fr. missing from rim. DR 8.0; DB 3.7; H 9.1. Fine, soft, reddish yellow fabric (5YR 6/8). Mottled black to grey, slightly metallic, slip outside; dull grey inside. Reserved underfoot. Straight wall profile with simple rim. Two vertical strap handles with

thumb-rests: rectangular finger-rests added at top of handle. Three grooves under gloss on belly. Uneven pedestal foot with mouldings.

4. F99-5011. GR3/3. Kantharos. Complete. DR 6.3; DB 3.4; H 7.4. Fine, yellowish pink fabric (5YR 7/6) with white specks and small voids. Surface pocked from lime eruptions; polished outside, rilling with finger prints inside. Dipped to lower wall in mottled black and red slip, thin, misfired. Simple vertical strap handles without thumb-rests. High pedestal foot with mouldings, separated from belly by a wide groove; narrow resting surface.

The drinking cups in the grave are all kantharoi, which were some of the more popular drinking cups in Classical and Early Hellenistic times. The name, *κάνθαρος*, is the Greek name for dung-beetle, but the word is also attested for a drinking cup in Antiquity. The shape, which in its Archaic and Classical versions had two highly swung handles and stood on a high pedestal foot, is often associated with the god Dionysos.

The four complete kantharoi all adhere to the same type with a few variations (Fig. 11). The basic shape is a deep cup with fairly straight walls. Three of them stand on a pedestal foot, while one has a splaying ring foot. Three have vertical strap handles with handle plates or thumb-rests; one has plain handles of the same shape. The shape is loosely related to the 'straight-walled' and 'baggy kantharoi' in Attic pottery,⁷ and the 'one-piece kantharos' at Corinth.⁸

In addition to the four well-preserved examples, the handle of a kantharos with knot handle was found (no 36). In all likelihood, since only a small frag-

⁷ *Agora* XXIX, 97-100, 260-61 nos. 170-82, Figs. 13-14, pls. 16-17.

⁸ *Corinth* VII,3, 74-76 nos. 378-88, pls. 15, 52.

Fig. 11. Kantharoi no. 1-4.

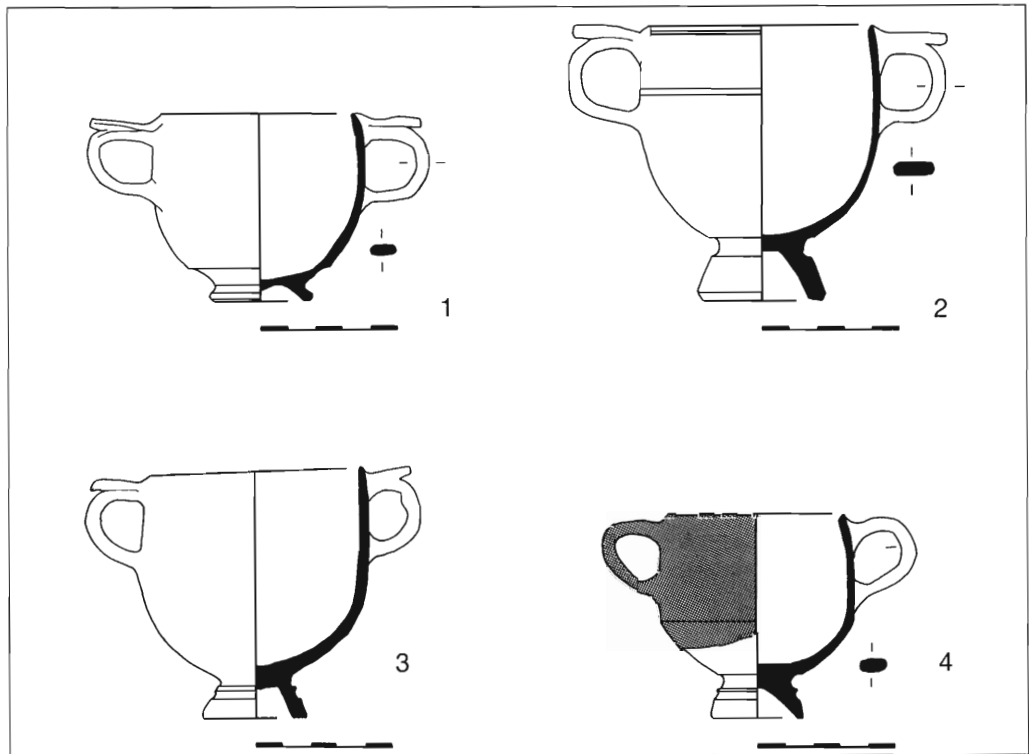

ment of the cup was found in the grave, it did not form part of the grave-goods but, along with a few other stray sherds, ended up in the grave by chance. Another possibility is, of course, that it formed part of one of the early depositions and later, in a broken state, most parts of it were removed. The reason for its presence in the grave notwithstanding, it is included in the catalogue of finds from the grave as an example of a distinctive but rather rare type.

Kantharoi were both produced in clay and metal, and although relatively few of the latter have survived, metal prototypes are often quoted as the origin of the shape. There was certainly some interdependency between the two media – and it is often impossible to de-

termine whether a stylistic novelty first appeared in one or the other. The evolution of the type can nevertheless be followed during a long tradition of producing clay kantharoi of the same basic type. The so-called *Kabirekantharoi*, deep cups with a rounded profile and two vertical handles, often with pointed spurs, from the Theban Sanctuary of the Cabiri, were produced from the fifth century B.C. both in a black-gloss variety⁹ and with figured decoration, mostly on clay ground.¹⁰ Their similarity to Attic kantharoi has long been noticed and Susan Rotroff makes a case for Boeotian potters, displaced after Alexander the Great's sacking of Thebes in 335 B.C., introducing the shape to Athens as the 'straight-walled kantharos' of the Hellenistic period.¹¹

⁹ *Kabirion* III, 27-28, 131, nos. 126-34 (There called *Kabirenskyphoi* as opposed to the black-figure kantharoi, called *Kabirenbecher*).

¹⁰ *Kabirion* IV, 1-74, pls. 1-18, 20-24.

¹¹ *Agora* XXIX, 97-99.

The proportions of some of the late Cabirian kantharoi are very close to our cup, although the handle treatment, clay and surface are all different.¹²

Apart from the likeness in shape with the Boeotian examples, which may be accidental, our kantharoi are firmly rooted in a local western Greek tradition, although there are important variations. One kantharos, representative of the western Greek style, was found in the grave at Trichonio,¹³ and others come from grave contexts at Patrae.¹⁴ Characteristic of all the published examples from Patrae and Trichonio, said to be Elian or of Elian type, is a more or less developed S-shaped profile, not evident on any of the Chalkis kantharoi, which either have a straight or slightly convex wall. The straight wall has been taken as

an early sign, and features on a kantharos with the, typically Elian, vertical ribbing, of the fifth and fourth centuries.¹⁵ A steeper vertical ribbing is still found on later kantharoi, with a marked S-shaped profile, from Elis itself.¹⁶

West-slope decoration is a common feature on kantharoi at many centres, such as Athens and Corinth,¹⁷ and cups found at Olympia, resembling ours in shape, feature incised decoration as well as the vertical ribbing, so characteristic of Elian pottery in the Late Classical and Early Hellenistic periods.¹⁸ In that context it should be noted that none of our examples shows any signs of painted decoration.

On purely morphological criteria, no. 1 must be considered the earliest of the



Fig. 12. Kantharos no. 1.
Photo: H. Frost.

¹² See, e.g., *Kabirion* IV, 53 no. 195, pls. 13.4, 21.2: „Wende 4./3. Jh. v. Chr.“.

¹³ *Trichonio*, 324, pl. 163a.

¹⁴ Δ. Κυριακού in *Γ'ΕλλΚεφ*, 190, pl. 133.

¹⁵ R. Eilmann, *OlBericht* III (1938-39), 50-55, Fig. 48.

¹⁶ V. Mitsopoulos-Leon, *ÖJh* 50 (1972-73), 212-14, Fig. 24; *ead.* and E. Pochmarski, *ÖJh* 51 (1976-77), 213-14, Fig. 23.

¹⁷ *Agora* XXIX, pls. 16-28, 31; *Corinth* VII,3, pls. 52-53.

¹⁸ *OF* XXIII, pl. 5.5, 8-12.

four complete kantharoi (Figs. 11, 12). It is lower than the later ones with a more rounded profile, and sits on an out-turned ring foot. The good quality of the black gloss is consistent with that found on many fourth-century vases.

The carination of the wall above the foot, a result of the scraped undercutting of the belly, leads one's thoughts to metal vessels, but is not necessarily an indication of direct imitation. Kantharoi, similar in style, were produced in both media simultaneously and it is very difficult to say with certainty which was the prototype, the metal or the ceramic version. A couple of silver kantharoi were found in Tomb II at Vergina, and although they are not exact parallels – the shape is more hemispherical and the foot is slightly different, higher than our ring foot example and lower than the pedestals on our three other cups – the likeness is unmistakable.¹⁹

One of the Vergina kantharoi has rectangular thumb-rests similar to ours.²⁰ It is a common type of handle decoration on ceramic kantharoi in the late fourth and third centuries, and if conceived as an imitation of a prototype in metal, it must have happened at the beginning of the series. Jürgen Schilbach, who published the Hellenistic fine ware at Olympia, thought the handles were copied from metal vessels when the shape emerged in clay.²¹ No metal kan-

tharoi have survived at Elis, so the assertion has to remain unproven.

A fragmentary kantharos with a convex upper body profile, similar to that of our kantharos, was found at Lousoi in northern Arcadia and dated in the third century B.C.²²

The following two kantharoi are in several respects very similar and it would be pure guesswork to range them chronologically one after the other on stylistic grounds (Figs. 11, 13, 14). Both have handle plates, a pedestal foot and a straight, or nearly straight, upper wall. They are also the same size, with a rim diameter of approximately eight centimetres.

The differences are only minor: one of them, no. 2, has a double groove in the handle zone where the other, no. 3, is plain; it has also a slightly higher pedestal with only a deep groove between foot and belly, where the latter, lower, pedestal is more elaborated and resembles the next kantharos in the discussion, no. 4. The profile of no. 2 is very slightly convex, whereas the upper wall of no. 3 is nearly straight.

Both kantharoi are good parallels to the Trichonio kantharos (Fig. 15).²³ As mentioned above, however, the Trichonio piece, like those published from the Hellenistic cemeteries in Patrae, has a

¹⁹ Vokotopoulou, *Guide*, 163-64, nos. Bε 63-64; M. Andronicos, *Vergina. The Royal Tombs and the Ancient City* (Athens 1984), 149, Fig. 109.

²⁰ Vokotopoulou, *Guide*, no. Bε 64.

²¹ *OF* XXIII, 60-61. Schilbach dates the event to c. 365, but in light of recent evidence at other sites (v. *Agora* XXIX, 18-36), one should perhaps allow for somewhat lower dates of the Olympian contexts in the fourth and third centuries.

²² Β. Μητροπούλου-Λεόν, in *Α'ΕλλΚεQ*, 23, pl. 4, no. K23/84 = *Α'ΕλλΚεQ*², 24, Fig. 2.

²³ *Trichonio*, pl. 163α.



Fig. 13. Kantharos no. 2.
Photo: H. Frost.



Fig. 14. Kantharos no. 3.
Photo: H. Frost.



Fig. 15. Kantharos from
Trichonio.
Trichonio, pl. 163α.



slightly S-curved profile and, in addition, an out-turned lip as well as two sets of double grooves in the handle zone. These differences are more likely to reflect different workshops than any chronological development.

The stylistically latest kantharos in the grave, no. 4, has done away with the thumb-rests on the handles (Figs. 11, 16). Late signs are the constricted foot and

the dipping, whereby the inside is fully coated and the outside, in a thin, dull slip, is covered only as far down as the belly. There is however nothing to indicate that it should be more than half a century later than the earliest vessels in our assemblage. A regional parallel to this kind of kantharos without additions to the handles comes from a grave in Naupactus (Fig. 17).²⁴ That grave, a stone cist like ours, contained six skeletons. The buri-

²⁴ Γ. Αλεξοπούλου, *AD* 49 (1999), B'1, 244, pl. 77δ.

Fig. 16. Kantharos no. 4.

Fig. 17. Kantharos from Naupactus. *AD* 49 (1999), B'1, 244, pl. 77δ.

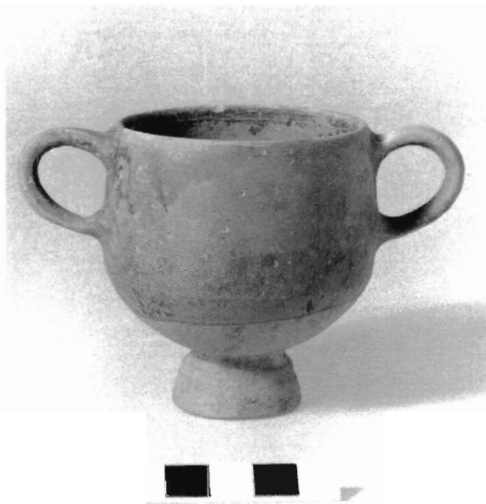

als were spread over a longer period, since its latest vases should be dated in the second century B.C.

To discuss stylistic development in pottery as if it were rigidly linear and following a scientific scheme is hazardous: it is more than likely that a particular pot, of which we say that it presents 'progressive' details of style, often could have been produced at an earlier date than a pot with more 'conservative' features. Although kantharos no. 4 is stylistically the latest of the four vessels, it is no. 3, which, owing to its find spot, can be attributed to the last burial. It is not to say whether this apparent flaw in the scheme of things is due to differences between the workshops or a longer 'shelf life' for one pot than the other.

Jugs

Filter jug (spouted *situla*)

5. F99-5014. GR3/3. Filter jug. Restored from more than 20 fragments. DR 6.5; DB

5.8; H 13.0 (incl. handle 18.6). Fine, soft, pale cream fabric (10YR 8/3), with small dark brown inclusions. Pale self slip as foundation for dark gloss. Reddish brown to dark grey on all surfaces including underside and inside. Drip mark on lower inside wall. Very worn. Incised plant stems/scrolls. Presumably ivy: all traces of paint worn off. Two grooves through gloss on upper wall beneath spout; a further two on lower body. Deep groove under gloss above foot. In-turned, flat rim with low knobs imitating metal pins or nail heads. Spout in the form of moulded lion's head (or satyr mask); filter as 7 pierced holes in wall inside spout. Basket handle attached to rim at spout and rear of jug with handle attachment. 3 bone frs. inside jug (2 rib, 1 radius from goat?), 1 sherd.

The filter jug is in many ways the most remarkable of the vessels in the grave (Fig. 18-21, 24-25). In the archaeological literature, the shape goes under the Latin term *situla* or the Greek *κάδος*; the former translates, besides a couple of secondary meanings, as a 'bucket for drawing water from a well' and the latter, although the ancient Greek word has a range of meanings,²⁵ is the term used in modern Greek literature for an-

²⁵ The entry in *LS* gives the readings 'jar or vessel for water or wine', 'liquid measure = ἀμφορεύς' and 'funerary urn': *LS*, 848.

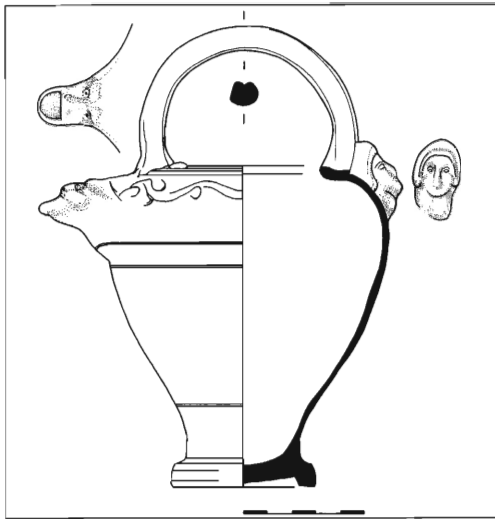

Fig. 18. Situla no. 5.
Drawing: A. Hooton.

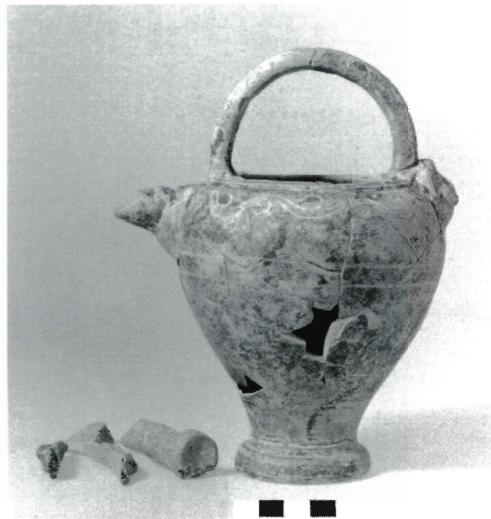

Fig. 19. Situla no. 5.
Photo: H. Frost.



Fig. 20. Situla no. 5,
detail of spout.
Photo: H. Frost.

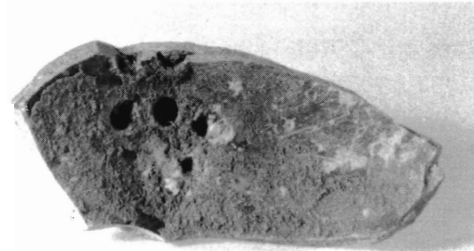

Fig. 21. Situla no. 5,
sherd with filter.
Photo: H. Frost.

cient buckets.²⁶ The vessel's function is however that of pouring wine and certainly not that of fetching water from a well, and it is therefore described here among the jugs. The terms *situla* and *κάδος* have stuck in analogy with the cylindrical metallic vessels from Italy equipped with a bucket handle, called

situlae irrespective of function. The jug described here should not be confused with the *θήλαστρον/feeder*, sometimes called 'filter jug' or '-vase' and whose function is disputed. The latter shape is a development of the *askos* with a strainer in the neck and a long tube as spout.²⁷ The sobriquet *situla*, which seems to have stuck, is in a way understandable: the general shape of the metal jug with spout and filter is but a variation of the 'bell-situla', which bears a greater resemblance to a modern bucket.²⁸

²⁶ Cf. e.g. E.C. Portale, in *Γ'ΕλλΚεQ*, 252 no.5, pl. 204ε. In modern Greek, *κάδος* is both a garbage bin and washing basket, but also a slightly literary word for *κουβάς*, i.e. bucket in everyday language.

²⁷ Kallipolis: E. Μπαζιωτοπούλου-Βαλαβάνη, in *Γ'ΕλλΚεQ*, 52, pl. 21; Athens: *Agora* XXIX, 180-83, n. 21 for bibliography.

²⁸ *Derveni*, 102-03, nos. Δ4, Δ6, pl. 111 and 122, no. Z15, pl. 134.

Fig. 22. Situla from Trichonio.
Trichonio, pl. 163Ḅ.



Our vase has a flat rim, bulges at the shoulder, which slopes in an elegant S-curve towards a narrow base, and sits on an offset ring foot. The handle is set directly on the thickened rim at the front and back of the vessel, with a low knob, in imitation of a metal nail-head, on each side of the handle. The spout is modelled in the shape of a lion's head (Fig. 20), and the wall behind it is perforated so as to form a filter (Fig. 21).

The shoulder was decorated in West-slope technique: all that remains on the badly damaged surface is the incised stem of a garland. The poor state of preservation is shared with the other vessels from the grave, which originally must have carried painted decoration:

the pyxis and, in all probability, some of the kantharoi.

The filter is the clue to the use of the vase: wine tended to be a rather raw product in ancient Greece, containing residue from the wine-making process, and had to be filtered before it was diluted with water to a more palatable mixture.

Another filter jug featured in the previously mentioned grave at Trichonio (Fig. 22). Zapheirou dated it at the turn of the fourth and third centuries B.C.,²⁹ chiefly comparing it with a bronze situla from Veroia from the second half of the fourth century and said to be rather more conservative in appearance.³⁰ The Trichonio jug is very similar to ours in profile, but differs in that it has a supplementary relief head on each side of the shoulder.

Found over a large area, from southern Russia to Italy, the origin of the shape has been debated.³¹ It exists both in clay and metal, but is more common in the latter material, which can be bronze or, less commonly, silver. The metal vase must have been the inspiration for the ceramic version. It is true that copying between the two media can go either way, but here the flat knobs on the rim are proof that the potter has looked at a prototype in metal.

The clay jugs found in Greece are made in the 'Greek manner', i.e. decorated with West-slope technique, whereas the

²⁹ *Trichonio*, 324, pl. 163Ḅ.

³⁰ Σ. Δρούγου and Γ. Τουράτσογλου, *Δ'ΕλλΚεῶ*, pl. 119Ḅ.

³¹ M. Candela, *Babesch* 60 (1985), 24-71.

Italian vases are classified as Gnathia ware.³² They are also heavier in shape than the Greek counterparts, and resemble the early metal prototypes to a higher degree.³³ Italian products do, however, occasionally find their way East. A miniature situla has been found at Lyttos in Crete, an island which otherwise did not receive much imported material from Italy in the Hellenistic period.³⁴

No such clear difference is apparent between metal situlae of Italian and Greek provenance, which leads to the argument of their origin. In Hellenistic times, pottery was to a large extent produced locally in imitation of widespread, 'international' shapes, but in the case of metal-ware, the likelihood of more centralized production is perhaps greater. Metal vessels could travel far and Greek situlae have been found even in Scandinavia.³⁵ As mentioned, stamnoid or spouted situlae³⁶ in bronze or silver are found in the Italian peninsu-

la from Etruria to Apulia; in the Balkans from Epirus and Macedon to Bulgaria and Russia, but seem to be largely absent from Southern Greece and the islands.

Scholars working with Italian material have advocated a production site in Italy, with exports reaching as far away as the Black Sea. Most of them, including Beazley,³⁷ classified the metal vases as Etruscan, whereas the clay imitations were thought to come from a number of areas. Later, Taras was put forward as the likely site of production of the metal jugs.³⁸

In this context it is perhaps curious to note that, whereas the vast majority of bronze and clay situlae found in Greece and the Balkans stem from grave contexts, those from Italy have, in most cases, an unknown provenance (i.e. from the art market). The large well-published cemeteries of Magna Graecia, such as Metapontion and

³² More a geographical than a technical distinction. Gnathia is the earlier development, but there were several centres of painted pottery, each with its own development, but not immune to mutual influences. 'West-slope', which is characterized by combined incisions and painted decoration, got its name after the location on the Athenian Acropolis whence a group of third-century pottery was published by Watzinger in 1901 ('Vasenfunde aus Athen', *AA* 26, 50-102), but the technique was practised earlier at e.g. Corinth. *Agora* XXIX, 41; *Knossos KPH*, 119.

³³ K. Schauenburg, *AA* 1981, 462-88.

³⁴ J.R. Green in A. Cambitoglou (ed.) *Studies in Honour of Arthur Dale Trendall* (Sydney 1979), 82, no. 14 (Herakleion Museum. Miniature situla with Gnathia decoration: lion-head spout and relief female head at base of handle, ca. 325 B.C.?).

³⁵ A bell situla from Keldby on the Danish island of Møn: P.J. Riis, *ActaArch* 30 (1959), 17-26, Fig. 15.

³⁶ *Stamnoid situla* (with and without spout: Beazley), *Situla a beccuccio* (Candela), *Typus III* (Schauenburg), *Typus C* (Kossatz-Deißmann), *Situle thrace* (Venedikov), *Σταμνοειδής κάδος* (Θέμελης and Τουράτσογλου).

³⁷ J.D. Beazley, *Etruscan Vase-painting* (Oxford 1947), 287-88.

³⁸ M. Candela, *Babesch* 60 (1985), 24-71, esp. 52-53, following G. Zahlhaas, *Großgriechische und römische Metalleimer* (Diss. Munich 1971), 88-107.

Fig. 23. Situla from Derveni.
Derveni, pl.34.



Taras, have produced surprisingly few situlae.³⁹

In an article published in 1977, it was proposed that the spouted situlae were produced in the Greek colonies on the east coast of the Black Sea. The type is present in that area from the early fifth to the early third century B.C., but the author's claim that it is to be considered a specifically Thracian type can only be explained by a lack of access to the literature or the finds from Italy and Macedon, which, by the 1970s, had already appeared.⁴⁰

In Greek publications, on the other hand, the location of a Macedonian

workshop is presupposed, but not located.⁴¹ The discussion, or lack of it, on the production of the metal vases reflects the rather serious geographical problem in archaeological scholarship: scholars who are mainly concerned with the Italian peninsula have often little knowledge of the Eastern Mediterranean, and those concerned with matters Greek are largely ignorant of Italian publications, and only very few manage to bridge the gap. Here is scope for a study, which should include the total corpus of situlae, and which should attempt to answer the question where, and at how many workshops, these metal vases were produced. The question is, however, somewhat academic in this context, since there cannot be any doubt that the imitations in clay were produced at a number of sites.

The spout on this type of situla is always in the form of a head, sometimes a satyr, more often a lion, and in rare cases a bull.⁴² Our vase is rather worn and one could be excused for seeing something else than a lion's head, e.g. that of a satyr, but a glance at the spout of a gold bucket from a tomb at Derveni in northern Greece reveals quite clearly that a lion must have been intended (Fig. 23).

Satyrs are very appropriate as spouts on a wine jugs, and the head at the rear

³⁹ Of the 231 graves analysed by Graepler, only two (nos. 46 and 136) contained spouted situlae. Of these, one was dated in the beginning of the third century (with one full-size and one miniature situla, the latter with Gnathia decoration), the other, with a squat and course profile, in the late third or early second century: Graepler, 90. The publications *Taranto* III,1 and *Metaponto* include no situlae at all.

⁴⁰ « [Le type] est peu connu jusqu'à présent par des trouvailles en Grèce ou en Italie du Sud et se rencontre principalement dans la moitié orientale de la Péninsule Balkanique. C'est pourquoi on peut le considérer comme un genre de situle thrace particulier. » : I. Venedikov, *Thracia* IV (1977), 63.

⁴¹ Π. Θέμελης in *Derveni*, 170-82, esp. 173-74; A. Sideris, *Revue Archéologique* 2000, 13-17.

⁴² *Derveni*, 103 no. Δ5, pl. 112.

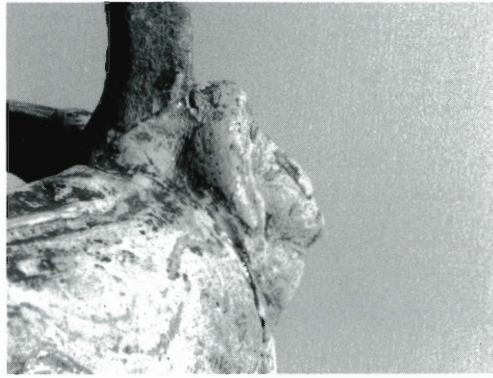

Fig. 24. Situla no. 5, handle attachment frontal view. Photo: H. Frost.

Fig. 25. Situla no. 5, handle attachment right profile. Photo: H. Frost.



Fig. 26. Situla no. 5, handle attachment left profile. Photo: H. Frost.

handle attachment on the situlae is also regularly taken from the Dionysiac sphere, with a portrait of a silen or a maenad.⁴³ In other cases, the rear head represents the goddess Athena, or Medusa. Neither of these is applicable to our jug: the head is rather peculiar and its rather poor state of preservation makes the details difficult to discern (Fig. 24). It could be a woman with a fillet around her forehead holding up a large roll of hair (Fig. 25). Women's hair is generally not supported by a headband immediately framing the forehead in this way, although Hellenistic female coiffures often carry a

fillet higher up on the head. Looking at the left profile of the head, there are traces of what indeed does look like hair (Fig. 26), and such a thick mane of hair is also seen on some theatre masks from the new comedy, always portraying young men.⁴⁴ A bronze oinochoe from Derveni has a heavily restored female head with straight hair as a protome at the upper handle attachment, which "resembles a theatrical mask".⁴⁵

The comparatively large bulge on the top of the head, combined with the narrow band framing the forehead, could, on the other hand, be not hair but a hat.

⁴³ A. Sideris, *Revue Archéologique* 2000, 9-10, Fig. 5.

⁴⁴ *MNC*³, I, 16-20, masks 10-14; II, 19-21, nos. 1AT 41-46, pl. 6: 325-250 B.C.

⁴⁵ *Derveni*, 35 no. A7, pl. 41.

Fig. 27. Terracotta figurine of young man wearing kausia. *BM Terracottas III*, no. 2177.



If that were the case, one would associate it with a *kausia*, the Macedonian cap adapted from the hat Alexander's soldiers encountered in Central Asia.⁴⁶ The hat, basically a woollen tube, closed at the top, with rolled rim, is known there as a *chitrāli* and is a familiar feature in the many pictures from the recent wars in Afghanistan. Its appearance on some Early Hellenistic terracotta figurines is remarkably similar to the way it is worn today.⁴⁷ The garment worn by our small figure does not bear such a likeness, but it is not improbable that what we see is a Greek adaptation or derivation. It is not unlike the hat on a terracotta head from Thessaly, broken from a figure of a young man (Fig. 27). In the British Museum publication the hat is described as a *kausia*.⁴⁸

Olpai

6. F99-5055. GR3/3. Olpe. Complete, handle mended, chipped rim. DR 6.7-7.1; DB 6.0; H 16.5. Medium, soft, reddish buff fabric (7.5YR 7/6), with rare white inclusions. Two grooves around neck, tripartite handle attached beneath rim and at shoulder, recessed disc foot.

7. F99-5013. GR3/3. Olpe. Complete. DR 4.9; DB 5.8; H 13.5. Fine, pale reddish yellow fabric (5YR 7/8), with rare large, red, black and white inclusions; and frequent small dark grey inclusions. Rare mica. Pale self slip. Dark brown painted band on shoulder and at rim. Everted rim. Vertical strap handle attached to rim and shoulder. Disc base.

8. F99-5012. GR3/3. Olpe. Restored from more than 30 fragments. DR 6.9; DB 7.6; H 20.7. Medium reddish buff fabric (7.5YR 7/6), with many small brown inclusions and voids. Rounded lip with mouldings at junction with neck. Rounded shoulder. Vertical strap handle with central ridge, attached outside beneath rim and to shoulder. Disc base.

The other three pouring vessels in the grave are of an altogether more common shape. They are all *olpai*, or round-mouthed jugs, simple vessels for pouring wine (Figs. 28-31). The Greek name *olpe* is today used to distinguish this shape from the *oinochoe*, or trefoil-mouthed jug. The latter name is the descriptive name for a wine-jug, whereas *olpe* in Antiquity meant an oil flask, such as was used at the Palaestra.⁴⁹

No. 6 (Fig. 29) is plain, without any visible coating, although given the state of preservation of the vessels in the grave,

⁴⁶ B.M. Kingsley, *AJA* 85 (1981), 39-46.

⁴⁷ *BM Terracottas III*, pl. 2, nos. 2011 and 2012.

⁴⁸ *BM Terracottas III*, 86, pl. 33, no. 2177.

⁴⁹ J.R. Green, *BICS* 19 (1972), 5.

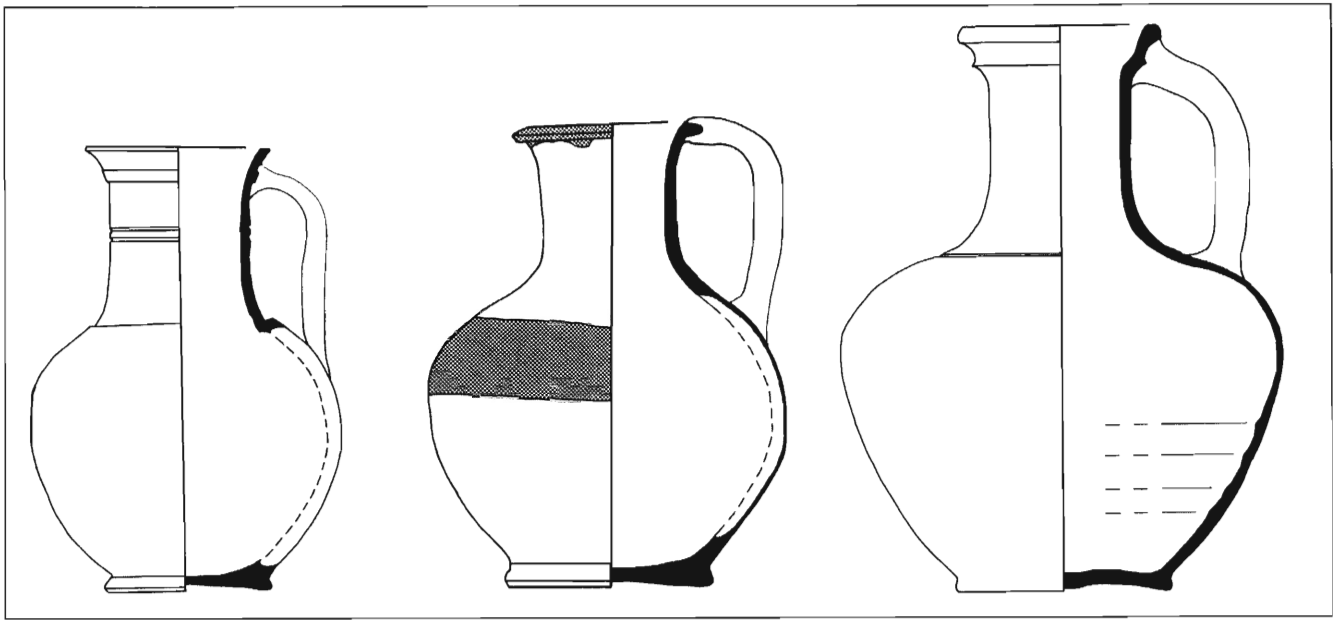
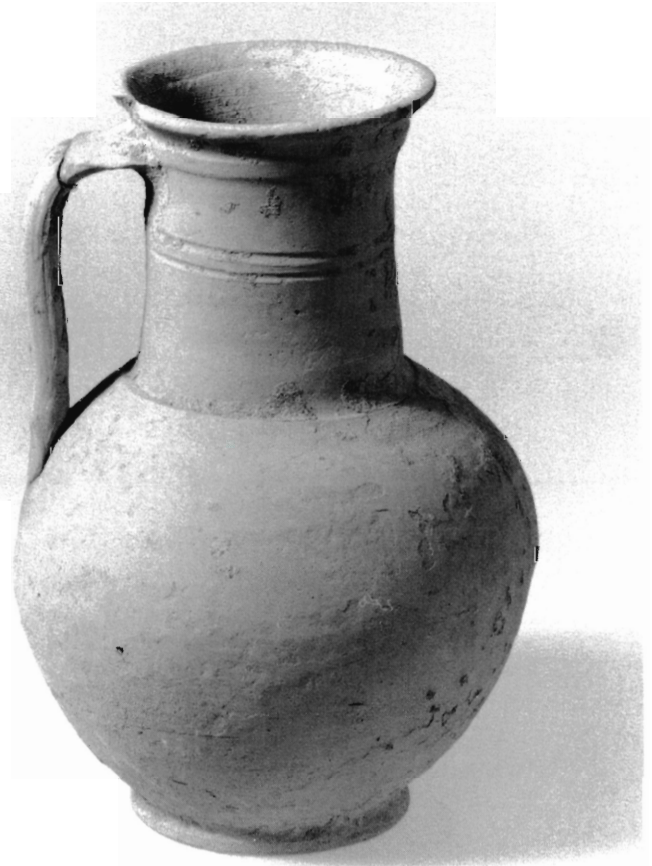

Fig. 28. Olpai nos. 6-8.

Fig. 29. Olpe no. 6. Photo: H. Frost.

it is quite possible that a slip would have worn off: compare with the pyxis (no. 14), which almost certainly carried painted decoration, and which has traces of slip only on the inside. The only attempts at decoration, which have been preserved on the olpe, are a pair of grooves on the neck, and a flat moulding beneath the flaring rim. A tripartite strap handle is attached at that moulding and to a point slightly above the largest diameter of the jug. With a height of 16.5 cm the olpe is not a very large jug, holding about half a litre of wine.⁵⁰ The other jugs in the grave are of comparable size.

A jug from the Dipylon Well at the Athenian Kerameikos lacks the moulding and the grooves and has a more pear-shaped body than our olpe.⁵¹ The resemblance is however



⁵⁰ 0.5101.

⁵¹ K. Braun, *AM* 85 (1970), 165, pl. 54, no. 24: from 'Abschnitt Ib', dated by Braun 'c. 300', by Braun 'c. 300', by Rotroff c. 300-280 B.C., cf. *Agora XXIX*, 26-27.

Fig. 30. Olpe no. 7.

Photo: H. Frost.

Fig. 31. Olpe no. 8.

Photo: H. Frost.

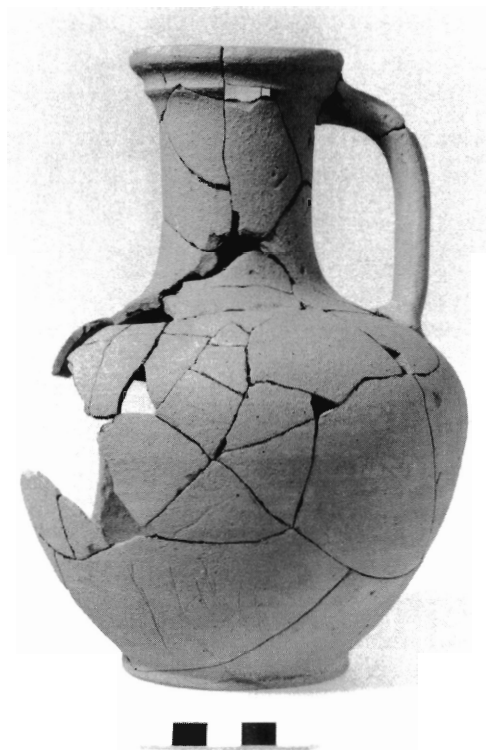
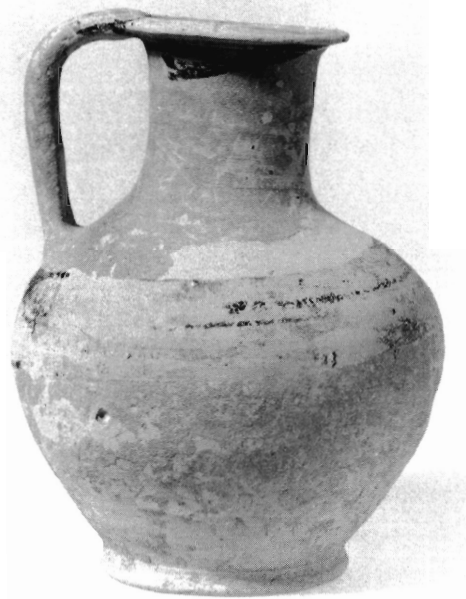

good enough to make a date of our jug in the first half of the third century B.C. plausible.

No. 7 (Fig. 30), with an everted rim and a broad painted band on the shoulder, is different from the other olpai in that the handle is attached to the rim, not below it. The same construction is seen on two jugs from the earlier mentioned cist grave in Naupactus with multiple burials.⁵²

Like the other two olpai in the grave, no. 8 (Fig. 31) lacks any preserved coating. Its body is more pear-shaped, and the neck narrower in relation to the body. In general terms, our three olpai

are akin to a series of jugs in Eretria, found in the third-century well, mentioned above in connexion with the bowls.⁵³ The out-turned rim of our no. 8 has mouldings, which are particularly close to those from Eretria,⁵⁴ but the type occurs at many sites and had currency for a very long time throughout the Hellenistic period. Jugs very similar to ours came from a well-dated house destruction on Delos and are as late as the first century B.C.⁵⁵

At both the mentioned sites, Eretria and Delos, the jugs were thought to have been used for pouring water rather than wine, and it is perhaps a natural interpretation of these simple olpai. The De-

⁵² Γ. Αλεξοπούλου, *AD* 49 (1999), B'1, 244, pl. 78γ.

⁵³ In the publication called '(Water-) Jar': S.G. Schmid, *E'EllKεQ*, 366, pl. 185, nos. 40-46.

⁵⁴ *Loc. cit.*, nos. 41-43.

⁵⁵ Π.Ι. Χατζηδάκης, in *E'EllKεQ*, 122, pl. 71α.

los jugs were uncoated, whereas the assemblage from Eretria presented both plain and coated examples. Given the poor state of surface preservation in the grave, we cannot know whether our *olpai* were coated or not, but it should not have much significance for which liquid was contained in the jugs. As we know from our own kitchens, many vessels serve multiple uses, and in the case of the grave, if the interpretation that we have four complete sets of grave goods representing a meal service is correct, the *olpai* must have served the same purpose as the filter jug, *viz.* to signify the presence of wine at the meal.

Food bowls

We continue the description of the pottery with a series of small bowls, which, in all likelihood, were used for serving food. They are four in number: a one-handler, a shallow bowl or dish, and two small echinus bowls.

One-handler

9. F99-5058. GR3/3. Bowl, one-handler. Restored from eight fragments. DR 9.0; DB 4.3; H 4.5. Fine, soft reddish yellow fabric (5YR 6/8) with small white inclusions. Black gloss, lustrous inside; dipped outside to foot, metallic. Groove beneath rim under gloss. Horizontal recurved handle, straight wall and rim, ring foot. Slip and fabric as (but more yellow than) *kantharos* no. 1.

Our one-handler is a small bowl with flaring ring foot, straight wall and slightly out-turned rim marked by a groove (Figs. 32-33). The horseshoe

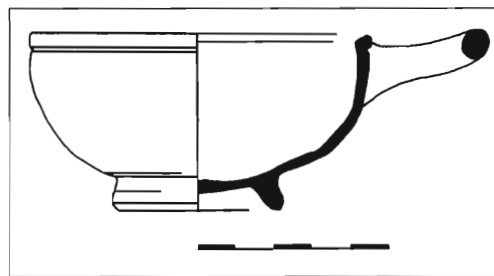

Fig. 32-33. One-handler no. 9. Photo: H. Frost.

handle is horizontal. It is a late version of a shape, which had been produced since Archaic times.

The origins of the shape should perhaps be sought in Athens, where the Hellenistic one-handlers from the Agora belong to the end of the fourth century and the early third, and form the end of a long Attic tradition.⁵⁶ Two types survive into the Hellenistic period: most common, and emerging at the very beginning of the fifth century, is the black-gloss bowl,⁵⁷ as opposed to the bowl with banded decoration, which had its heyday in the Archaic period.⁵⁸ The second type to survive past the Classical period is the 'deep' version with in-

⁵⁶ *Agora* XII, 124-27, nos. 724-76, pls. 30-31, Fig. 8.

⁵⁷ *Ibid.*, nos. 744-63.

⁵⁸ *Ibid.*, nos. 724-43.

curved rim,⁵⁹ which emerged at Athens in the middle of the fifth century. It is the predecessor of the so-called echinus bowl, a handle-less version of which becomes ubiquitous in the Eastern Mediterranean in the third to first centuries B.C. As a one-handler, it does not survive at Athens beyond the first quarter of the third century,⁶⁰ but appears elsewhere at regular intervals alongside the handle-less echinus bowl.⁶¹ It is perhaps a sign of traditionalism in Aetolian pottery-making that the ‘echinus bowl’ version of the one-handler, which supersedes the old shape in many areas of the Hellenistic world, has not been found at Chalkis.

The ‘shallow’ one-handler of the Early Hellenistic period at Athens is in essence a ‘bowl with out-turned rim’ provided with a handle, and does not lend itself to direct comparison with our straight-rimmed and grooved example from Aetolia. The profile is in fact more reminiscent of the thinner and more fragile two-handled bowl – *tazza biansata ad anse orizzontali* or *bolsal* – current in Magna Graecia in the fourth century and beginning of the third.⁶² The Attic *bolsal* of the late fourth cen-

tury has a heavier profile with a broader base than both the Italic version of it and our one-handler.⁶³

One-handlers have often been described as drinking vessels.⁶⁴ More plausibly, however, they were used as bowls to serve sauces, condiments and other foods. In her recent publication of Hellenistic tableware from the Athenian Agora, Rotroff did indeed place the one-handlers in the section of vessels for food service although she left the question of their use open.⁶⁵ Sparkes and Talcott, in the standard work for Attic tableware in the Archaic and Classical periods, thought that the one-handler was mainly a drinking vessel.⁶⁶

While, in the Classical and Hellenistic periods, there existed a plethora of cup shapes clearly intended for drinking, the known shapes for serving and eating food are fewer. Flat plates are relatively rare, but there was clearly a need for bowls for serving and eating, since the ancient Greek diet included several kinds of sauces and porridges and such semi-liquids. Although the question of the practical use of the bowls might appear academic, it is relevant in this con-

⁵⁹ *Ibid.*, nos. 764-70.

⁶⁰ *Agora XXIX*, 155-56, 329, nos. 856-60 (‘shallow’); 861-65 (‘deep’), Fig. 58, pl. 71; appendix I, graph 6.

⁶¹ J. Eiring, *E’ΕλλΚεQ*, 58, pl. 29b:1-3; N. Vogeikoff, *E’ΕλλΚεQ*, 71, pl. 36a.

⁶² Taras: *Greci in Occidente*, 330, nos. 320-21.

⁶³ *Agora XXIX*, nos. 168-69

⁶⁴ *Kerameikos IX*, 49; V.R. Anderson-Stojanović *Δ’ΕλλΚεQ*, 15, pl. 5, no. IP 705; M. Elliott, in *Metaponto*, 669.

⁶⁵ “it is a matter of debate whether the one-handler was used for liquids or solids”: *Agora XXIX*, 155.

⁶⁶ They refer to practical experiments which “have proved the one-handler an excellent bowl to drink from, though it may also have held solids, porridge or gruel”, and that it was “an ideal bowl for travellers and soldiers, as it is flat, can be attached to the belt or knapsack, and is thick enough to stand hard wear”: *Agora XII*, 124.

text, since it determines our interpretation of the grave goods. The vessels were deposited as representations of actions in real life, and as such the cups symbolize the drinking and the jugs represent the presence of wine. Although small bowls very well may have been versatile in their real-life use, in the grave they clearly represent the serving of food.

Sparkes and Talcott refer to, and cite, possible ancient names for the shape as *κάναστρον* and *κάναθον*, as originally suggested by R.M. Cook,⁶⁷ or *τρούβλιον*. The former terms are derived from *κάννα* (wicker), and had, along with *κάνεον*, quite plausibly the meaning of basket at first, later extended to its terracotta equivalent. Its connexion with the one-handler, which if anything does not resemble any known basket shape,⁶⁸ comes from an Attic base-herd found at Naukratis, inscribed *ΑΡΤΟΜΟΝΟΣ ΤΟ ΚΑΝΑΣΘΟΝ ΤΟΤΟ*.⁶⁹

Terms for vases varied over time and were very regional in their usage, and it is therefore impossible to say that a particular name was in general usage in the

ancient Greek world, at least not exclusively regarding a particular shape. Both *τρούβλιον* and *κάναστρον* / *κάναθον* were probably terms applied to the one-handler at a certain time (attested fifth to third centuries B.C.) and place (Attica), but there were certainly other names which are not known today. In the case of the former term, there are reasons to believe it was connected with a vessel for eating, not drinking.

Τρούβλιον is a generic term for bowl, and also a measure of medicine.⁷⁰ The verb used by Aristophanes in connexion with *τρούβλιον* is *ῥοφέω*,⁷¹ which translates as 'to sup greedily up, gulp down' or 'drain dry, empty'.⁷² And it does not mean 'to drink', for the same Aristophanes says that the *τρούβλιον* was used to serve sardines from Phaleron:⁷³

τοτὲ μὲν ἐρᾶ φαγεῖν ἀφύας
Φαληρικὰς τρέχω ἅπ' ἀφύας λαδῶν
ἐγὼ τὸ τρούβλιον

The noun derived from *ῥοφέω* is *ῥόφημα* or *ῥύφημα*, and Hippocrates says that *ῥυφήματα* were invented for people who were too frail to take in sol-

⁶⁷ R.M. Cook, *Classical Review* n.s. 1 (1951), 9; M.J. Milne, in J.V. Noble, *The Techniques of Painted Attic Pottery*, rev. ed. (London 1988), 192-94.

⁶⁸ The existing evidence is limited by the nature of the material to depictions of wickerwork, and does probably not extend to the full range of forms one might be expected to find in the shops. Baskets, however, normally have vertical handles attached to the edge, not horizontal ones. One could easily conceive the shape of the small one-handler reproduced in metal or wood, but wickerwork?

⁶⁹ C.C. Edgar, *BSA* 5 (1898-99), 56, pl. 5 no. 111.

⁷⁰ *Agora* XII, 124; *RE* VII A1, cols. 710-11.

⁷¹ «εἰρήνης ῥοφήσει τρούβλιον», *Acharnenses* 278; «μισθοῦ τρούβλιον ῥοφήσαι», *Equites* 905.

⁷² *LS*, 1575.

⁷³ *Aves* 76-77.

id, flour-based food (ξηρὸν σιτίον ἢ μάζαν ἢ ἄρτον). The weakest had to live on pure liquids, πόματα.⁷⁴

Τρύβλιον appears in a list of pot-names on a late fourth - or early third - century sherd at the Athenian Agora,⁷⁵ after λήκυθος and ἡμίχουν and before ὄφεϊα. The latter word has not been attested elsewhere and must associated with ὄφέω and ὄφημα, and from its position in the list, be in the same category of vessels as τρύβλιον.

Although very much a utilitarian dish, and thus mainly found in settlement contexts, the one-handler appears in graves elsewhere than at Chalkis. In Late Archaic and Classical contexts at the Kerameikos, one-handlers reportedly occurred only in child graves.⁷⁶

Our bowl is stylistically close to one-handlers from Isthmia, found in a well dating from the late fourth or early third century.⁷⁷ A one-handler from a cistern, also at Isthmia, shows features which could be later in date, such as the disappearance of the groove beneath the lip and the higher, and slightly more constricted, ring foot. The context was dated by Rhodian amphora stamps, the latest from the decade 280-270 B.C.⁷⁸ At Corinth, just as at Athens, the echinus-bowl variety of the one-handler exists at

the same time, i.e. in the same archaeological contexts,⁷⁹ although the echinus bowl here occurs already in the fifth century B.C.⁸⁰

The popularity of this shape at Chalkis from very early times is attested by an extraordinary amount of fragmentary bowls and cups with horizontal recurved handles attached to or near the rim, found in settlement contexts at the site. The presence of this complete bowl in the grave is important, as it confirms the survival of the shape into the Hellenistic period, and useful for the dating of fourth and third century levels in the main excavations, which otherwise may have produced meagre and fragmentary material. The Chalkis bowl is the product of a local development of the shape.

Shallow bowl

10. F99-5062. GR3/3. Echinus bowl, small, shallow. Complete. DR 9.2. DB 4.8. H 3.1. Fine, soft fabric, yellowish pink (5YR 7/6). Worn black gloss on all surfaces. Fabric and slip identical with kantharos no. 6. Deep concentric groove at centre of floor with two further grooves around tondo, all unevenly scraped through slip. Tool-marks from turning outside beneath rim. Tall, bevelled ring foot.

This shallow echinus bowl (Figs. 34-35) is an example of a Classical shape which continued in production into the Hellenistic period. The shape was cre-

⁷⁴ Hippocrates, *VM* 5-6.

⁷⁵ *Agora XXI*, 10 no. B12, pl. 2.

⁷⁶ *Kerameikos IX*, 49, Figs. 19, 40, pl. 80.

⁷⁷ V.R. Anderson-Stojanović, *Hesperia* 62 (1993), 278 nos. 28, 29, Fig. 7, pl. 60.

⁷⁸ *Ead.*, *Δ'ΕλλΚεσ*, 15-16, pl. 5, no. IP 705.

⁷⁹ *Ead.*, *Hesperia* 62 (1993), 278 no. 30, Fig. 7.

⁸⁰ The bowl with incurved rim ('type 1') seems, according to Elizabeth Pemberton, to be most popular in the second half of the 5th century, whereas the straight-wall type (type 2) appears in the early 4th century and continues into the 3rd: *Corinth XVIII*, 1, 36-38.

ated in the fourth century B.C. or, at the earliest, in the fifth.⁸¹ At Athens there were two types current in the early Hellenistic period. One, the Classical type, which had survived without much change, was often decorated with stamped palmettes. The other was a Hellenistic adaptation, less carefully made and without decoration. The shallow bowl was the most common form in Athens during the Late Classical period but was overtaken in popularity by the deeper echinus bowl in the course of the third century.⁸²

The shape continued longer in Italy, where it was one of the most characteristic shapes in black-gloss Campana ware. Decoration with joined palmettes and rouletting is also a feature on Italian bowls.⁸³

Pottery exports from Campania began seriously in the second century B.C. and, although rare in mainland Greece, Campana A and B ware has been found in abundance on Delos.⁸⁴ Our vases are earlier than the time of the great influx of pottery from Southern Italy, but are not unlike the Campana shapes, thus hinting at contacts between western Greece and Italy already in the early Hellenistic period.

While there have been some doubts about the use of the one-handler, there cannot be any question of treating this shallow bowl as anything but a dish for serving food.⁸⁵

Small echinus bowls

11. F99-5042. GR3/3. Echinus bowl, small ('saltcellar'). Complete. DR 5.5; DB 3.9; H 2.9. Fine, soft, yellowish pink fabric (5YR 7/6) with small voids and grey and white inclusions. Dipped inside and upper half outside. Black to brown slip, ochre where thin: dull inside, semi-lustrous outside. Tool-marks from turning outside. Fabric similar to that of the unguentarium (no. **13**), but is more pink. Surface sandy to the touch.

12. F99-5041. GR3/3. Echinus bowl, small ('saltcellar'). Found containing one shell (see below no. **33**) Complete. DR 5.8; DB 3.4; H 3.9. Fine, soft, yellowish pink fabric (5YR 7/6), mottled yellow and red. Worn, flaking, black, grey and brown, dull slip on all surfaces. Conical recessed foot, bevelled near base. Not the same fabric as that of the echinus bowl no. **11**.

These small bowls are a deeper shape than the previous and have a more incurving rim (Figs. 36-38). Bowls of this size are classified in the Agora and Corinth publications as small, footed 'saltcellars'.⁸⁶ They were a popular shape at Athens in the fourth century but

⁸¹ *Agora* XII, 131-32.

⁸² *Agora* XXIX, 161-62.

⁸³ *Campana A* bowl in Melbourne, mid third century B.C.: P. Connor and H. Jackson, *Greek Vases at the University of Melbourne* (Melbourne 2000), 190 no. 70. The shape is not dissimilar to our bowl, although larger, and stamped with high quality decoration.

⁸⁴ J.-P. Morel, 'Céramiques à vernis noir d'Italie trouvées à Délos', *BCH* 110 (1986), 461-93.

⁸⁵ *Agora* XXIX, 161.

⁸⁶ "[max. diameter] between 0.074 and 0.062 m": *Corinth* VII,3, 30, nos. 46-71; "usually between 7 and 8 cm. [rim diameter]": *Agora* XIX, 167, nos. 1075-89). The Chalkis bowls are slightly smaller than the Attic ones; both under six centimetres at the rim, they are close in size to the smallest Corinthian examples.

Fig. 34-35. Shallow bowl
no. 10. Photo: H. Frost.

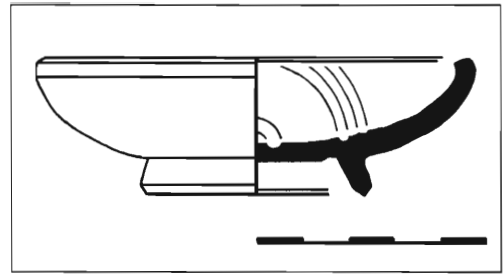

Fig. 36. Small echinus bowls
nos. 11-12.

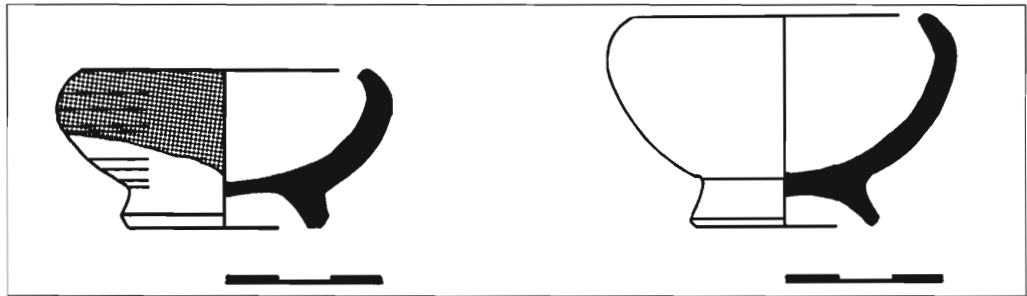

Fig. 37. Small echinus bowl
no. 11.
Photo: H. Frost.



Fig. 38. Small echinus bowl no. 12, with shell found inside it. Photo: H. Frost.

survived into the Hellenistic period. Morphologically the third-century bowls are distinguishable in that they have lost the grooved resting surface, characteristic of the Classical bowls. The foot treatment of the Chalkis bowls is different from the Athenian manner but the proportions of our bowls correspond well with Attic examples dated in the first quarter of the third century B.C.⁸⁷

Bowls made at Corinth perhaps provide even better parallels, as they generally have thinner walls than the Attic products. At Eretria, a well deposit from the first half of the third century, mentioned above and thought to date from the time of the Chremonidean War (267-262/1 B.C.), has produced a small bowl, very similar to the Chalkis ones.⁸⁸

As in the case of the one-handler, the echinus bowls have often been described as drinking vessels.⁸⁹ Anyone who has

⁸⁷ *Agora XIX*, 347, nos. 1082-83, Fig. 65, pl. 79.

⁸⁸ S.G. Schmid, *E'EllKeg*, 361-63, 365, pl. 182 no. 20.

⁸⁹ J. Schäfer, *Pergamenische Forschungen 2* (Berlin 1968), 37, nos. C13-C20: „*vorwiegend dürften die Nöpfe als alltägliches Trinkgefäß benutzt worden sein*“.

tried to drink from a vessel with an incurving rim will, however, have realized that such a shape is not very well suited for the purpose.

Other vessels

Unguentarium

13. F99-5039. GR3/3. Unguentarium. Nearly complete with 75% of rim. DR 1.8; DB 2.5; H 11.6. Fine, soft fabric, reddish buff (7.5YR 7/6) and paler. Pale slip; nine painted brown bands on neck and shoulder and two bands on lower body. Short fusiform unguentarium. Everted

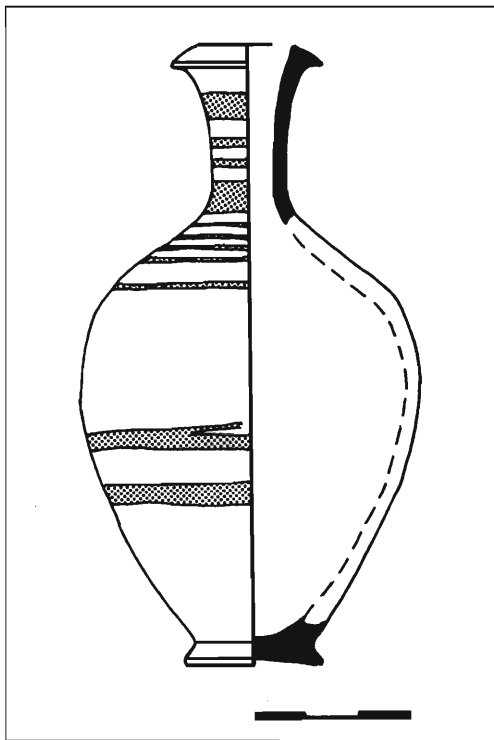

Fig. 39. Unguentarium no. 13.

rim. Slightly recessed disc foot. The lower wall describes a convex curve, not concave, as in the unguentaria with higher and narrower, stemmed foot, which are later in date.

There was only one unguentarium – a container of perfume – in the grave (Figs. 39-40). It is a fairly common shape at most Eastern Mediterranean sites and is found in settlement contexts⁹⁰ as well as in graves, but chiefly known for its ubiquity in Hellenistic funerary contexts. While most graves contain one or two, in some instances hundreds of unguentaria have been found in one grave,⁹¹ sometimes associated with a single burial. It can best be described as a bottle with narrow base and neck swelling to a bulbous shape in the middle of the body. Most often without handles, it occasionally appears with two rudimentary lugs on the shoulder,⁹² and sometimes with upright rolled handles.⁹³ Its function as an unguent vessel, or container of perfumed oil, is a presumption, albeit in all probability correct, and as such the unguentarium is the successor of the Archaic alabastron and Classical lekythos, both names which are attested in Antiquity. The term unguentarium, on the other hand, is a modern invention, although Pliny refers to *vasa unguentaria* for vessels made of alabaster.⁹⁴

The origin of the shape is probably to be sought in the East, although some scholars have insisted that its early models are

⁹⁰ The neck of an unguentarium of the same type was found in a floating level in the Hellenistic settlement of Chalkis: S. Houby-Nielsen *et al.*, *SPR*, 234, fig. 12.

⁹¹ See for instance chamber tomb 'beta' at Viale Virgilio, Taranto, with 122 pieces, 108 of which carried banded decoration: *Taranto* III,1, 101-4, pl. IV.2.

⁹² *Knossos KPH*, 124, Fig. 3.16d; Π. Δροσίνου, *Ε'ΕλλΚεQ*, 40 no. Π 6362, pl. 17; *Taranto* III,1, 258, fig. 192.

⁹³ Graepler, 96-97, no. 611/11.

⁹⁴ Plin. *NH* 36.60.

Fig. 40. Unguentarium
no. 13. Photo: H. Frost.

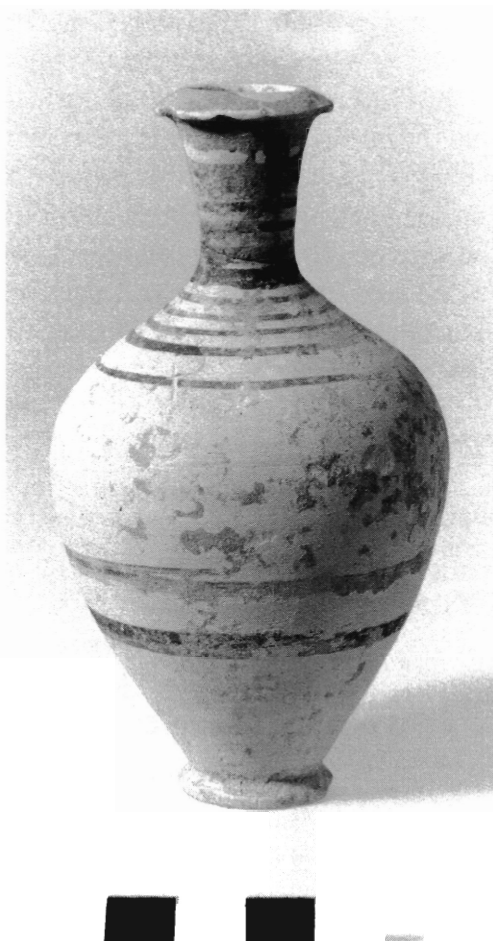

to be found in the Western Mediterranean. Hellström refers to the shape's similarities with Campanian lekythoi and points out that early unguentaria were found at Ampurias.⁹⁵ There, unguentaria were found in graves dating as early as the beginning of the fifth century B.C.⁹⁶ Still, spices and perfume were distributed from Arabia to the West, not vice versa, and it is most likely that the containers for these commodities should be an invention of the area of production rather than the market. The possibility remains

that the produce was exported in bulk quantities in larger containers, but that fails to explain the presence of large numbers of unguentaria in the East. It is quite inconceivable that perfume containers, found in the Middle East, should have travelled empty from e.g. Athens. Whatever the origin of the shape, it was widely produced from the early third century and onwards. Local products are often lacking in quality when intended for immediate use in graves.⁹⁷

The shape has some parallels in metal as well. A silver bottle from the fourth century, found in a Tarentine grave, has a pear-shaped body with lower centre of gravity, but the basic idea is the same, as is, probably, the function.⁹⁸

A special category of unguentaria produced rather better products in grey ware, which must derive from a single source. They are found in large numbers at many sites in the Eastern Mediterranean, and presumably traded along with their contents. The origin of these grey unguentaria has not yet been determined: Thompson first suggested Syria as a likely place of production, whereas Westholm preferred Egypt. On account of their frequency at Athens, Hellström proposed Attica, in spite of the fabric, which is not found in other Attic products.⁹⁹ A further argument for the shape originating in Greece and not the Middle East was put forward by Berlin, who pointed out that fusiform unguentaria appear earlier in Greece than at eastern

⁹⁵ *Labraunda* II.i, 25.

⁹⁶ *Ampurias* I, 164-66, fig. 134, no. 10 (Inhumación Bonjoan no. 23).

⁹⁷ *Knossos KPH*, 123.

⁹⁸ Taranto, Museo Archeologico Nazionale, inv. 119.170: *Greci in Occidente*, 100, 118 no. 92.

⁹⁹ *Labraunda* II.i, 25.

sites.¹⁰⁰ Still, there are strong arguments for insisting on an eastern production of these vases in that the fabric is undeniably alien to Attica.¹⁰¹ If this specific category of unguentaria, which enjoys such wide-spread distribution, was produced at a single site, it should be sought at the origin of the produce. Syria remains, in this light, a strong candidate for the production of grey unguentaria. We shall have to await results from scientific analyses, comparing the fabric of unguentaria found in Greece with that of Eastern ones.

The stylistic changes over time, as reflected in the Attic material, were first described by Thompson¹⁰² followed by Knigge¹⁰³ and Rotroff. An effort to chart the development of the shape at Corinth, based on the unguentaria from Athens, was made by Pemberton.¹⁰⁴ Chronologically, her division between early and later types, with successively more attenuated profiles, makes sense. Still, although there is little doubt about the general development towards an ever more attenuated profile, coupled with the emergence of a stemmed foot, which grows taller as the shape becomes narrower, a reliable date is, in most cases, difficult to give.

The unguentarium in the grave was not part of the grave goods of the last burial, but was part of the material pushed into the northwest corner (Fig. 9). The fabric is fine and soft with a smooth surface; the colour is reddish buff and the vase could very well be a local, or regional, product. A grave in Thessaly, also a multiple-burial cist, produced two unguentaria dated from the beginning of the third century B.C. to the third quarter. One of the unguentaria is very similar to ours in its proportions.¹⁰⁵

Pyxis

14. F99-5047. GR3/3. Pyxis. Complete. Eight fragments. Lid DR 9.5, DB 3.4, H 7.5; Body DR 8.3 DB 6.0, H 9.4; Assembled H 12.0. Fine, soft and powdery, reddish yellow fabric (5YR 6/8). Surface reddish buff (7.5YR 7/6). Red slip preserved on inside of box only. External surface eroded. Cylindrical pyxis with flange on high pedestal foot. Reversible lid with low ring foot.

Pyxides as containers for jewellery and other trinkets are known since the earliest of times, although the name, derived from πύξος or box tree, is not used for a box, irrespective of what material it is made of, until the Hellenistic or Roman period.¹⁰⁶

¹⁰⁰ *Tel Anafa* II, i, 58-61.

¹⁰¹ Rotroff is not entirely convinced of their Attic origin: *Agora* XXIX, 176-77.

¹⁰² H.A. Thompson, *Hesperia* 3 (1934), 472-74 (=HPT, 172-74).

¹⁰³ *Kerameikos* IX, 59-60, pls. 96-98. The closest parallel to our unguentarium in the Kerameikos material is one from a grave with two unguentaria and a bronze pin (*op.cit.*, 184 no. E 82.2, pl. 96,1). The grave was tentatively dated in the last quarter of the fourth century by morphological criteria.

¹⁰⁴ E.G. Pemberton, 'Ten Hellenistic Graves in Ancient Corinth', *Hesperia* 54 (1985), 271-307.

¹⁰⁵ Μ.-Φ. Παπακωνσταντίνου, *Δ'ΕλλΚεΘ*, 54 no. Κ 4438, pl. 41.

¹⁰⁶ *DNP* 10, 672-74. In modern archaeological literature, *pyxis* is the accepted term to describe lidded vessels from the Neolithic period onwards: P.P. Betancourt, *The History of Minoan Pottery* (Princeton 1985), 11, 13. The Greek word for the plant, πύξος, gave the Latin *buxus*, box tree, whereas the word πυξίς, for a box originally made of box wood, gave Latin *pyxis* and Late Latin *buxis*, whence the English word *box*.

Fig. 41. Pyxis no. 14.

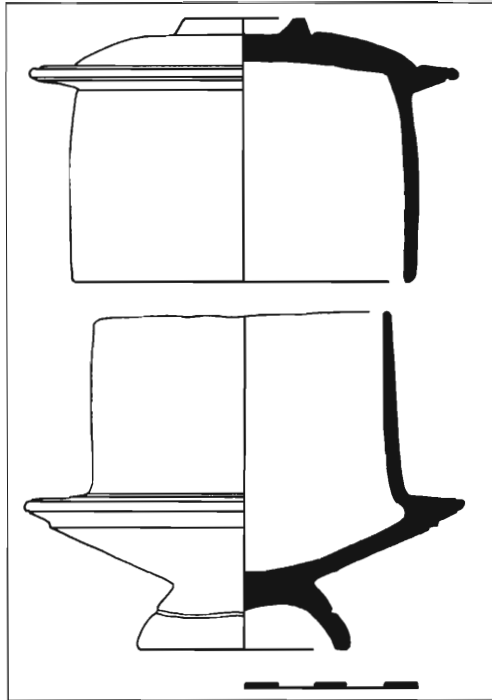

Our pyxis (Figs. 41-42) consists of a cylindrical container on a pedestal base with a lid, which slides over the vessel to a flange at the junction between the belly and the cylinder wall. The lid is equipped with a flange between its cylindrical wall and the dome to match the flange of the container and, in lieu of a knob, a low ring, which functions as a foot when the lid is reversed. The shape is based on an invention of the fifth century B.C., classed at Athens as pyxis 'type B', where the early versions at times carried black- and red-figure decoration on the lid.¹⁰⁷

As is so often the case, different publications use different terminologies to

Fig. 42. Pyxis no. 14.
Photo: H. Frost.



¹⁰⁷ *Agora XII*, 174-75.

describe variations of the shape. The Attic ‘type B’ is known from Macedonian contexts as ‘type A’.¹⁰⁸ Zoë Kotitsa, in her recent monograph on the Hellenistic pyxides,¹⁰⁹ refers to the shape as ‘*Typus I*’; her ‘*Typus II*’ being the – much rarer – pyxis with moulded feet. At Athens, where it is not really current, it is referred to as a subgroup of ‘type B’ and in Macedon as type B.¹¹⁰

Type I, to borrow Kotitsa’s term, is by far the most common type of Hellenistic pyxides. Since the shape developed at Athens from a Classical precursor, it is not surprising that most early examples should be Attic, like a pyxis from a well-dated fourth-century grave near Thessalonica. It has a low wide drum with a concave profile and a low, wide ring foot.¹¹¹

A pyxis found at Kallipolis in Aetolia, dated by its decoration in the third century B.C. and thought to be of either Boeotian or Cretan origin, has a low, fairly wide ring foot and an elaborate knob in the shape of a hollow globe, which is reminiscent of the miniature vases on the lid of some Geometric funerary vessels.¹¹²

A pyxis in Copenhagen (Fig. 43), with a mould-made satyr head on the lid, was



Fig. 43. Pyxis in Copenhagen. Ny Carlsberg Glyptotek.

bought by Einar Dyggve, the architect of the Greek-Danish excavations at Calydon, at Mesolonghi in the 1930s. It was said to have come from Angelokastro, ancient Konope /Arsinoë.¹¹³ Although it is published as Macedonian and dated in the first half of the second century B.C.,¹¹⁴ Kotitsa suggested the possibility of an Aetolian manufacture.¹¹⁵ She dated the pyxis in the third quarter of the second century B.C., stating that its broader ring foot is stylistically later than that of a resembling piece from a grave in Epirus, which also contained a coin from the late fourth century. The pyxis was compared with

¹⁰⁸ *Macedonia*, 166.

¹⁰⁹ Kotitsa.

¹¹⁰ *Agora XXIX*, 190; *Macedonia*, 166.

¹¹¹ N.X. Κοτζιάς, *AE* 1937, Γ', 891-92, Figs. 25-26.

¹¹² Ε. Μπαζιωτοπούλου-Βαλαδάνη, in *Γ' ΕλλΚεο*, 52, pl. 22. The ‘knob’ resembles the miniature thymiaterion found in Cretan graves: *Knossos KPH*, 125, Fig. 3.17,b-c.

¹¹³ Bommeljé, P. Doorn *et al.*, *Aetolia and the Aetolians* (Utrecht 1987), 77.

¹¹⁴ A.M. Nielsen and J.S. Østergaard, *The Eastern Mediterranean in the Hellenistic Period. Ny Carlsberg Glyptotek* (Copenhagen 1997), 151-52, no. 151.

¹¹⁵ Kotitsa, 150-51, pl. 53, no. Ait?1*.

Early Hellenistic examples from Veroia.¹¹⁶ The proportions are similar to ours, although the lid and the lower ring foot are diverging features.

The pyxides at Veroia differ from ours in that the diameter of the lid is considerably larger than that of the container, resulting in a wide gap closed only at the lower flange,¹¹⁷ where our lid and container fit tightly together.

Perhaps surprisingly, most pyxides from grave contexts are, as in our case, found empty: that is also true of graves, which are believed to be untouched since deposition. If indeed the pyxis were intended as a container for jewellery, the placing of an empty vessel in the grave would indicate a certain parsimony by the relatives of the deceased. That kind of economical thinking is however not always the practice in earlier periods, as evidenced in a Protogeometric tomb at Knossos, where a plain pyxis contained a collection of jewellery.¹¹⁸ On the other hand, in a grave at Elis, approximately a century later than ours, a wooden box had been placed by the feet of the deceased woman. The contents of the “vanity chest” were a mirror, tweezers, a pair of scissors, an unguentarium, and an – empty – pyxis.¹¹⁹

Miniature

15. F99-5056. GR3/3. Miniature krateriskos with basket handle found inside kantharos (no. 3). Complete. DR 3.2; DB 1.5; H 4.4. Plain.

Miniatures are at times slavish copies of vessels in larger sizes, but this krateriskos could be called a mixture of a krater and a basket, and so has no clear prototype (Fig. 44). It was found inside the kantharos no. 3 (Fig. 14).

Miniature vases are sometimes, but not exclusively, found in child graves.¹²⁰ In the Classical and Hellenistic periods, they are found in great numbers in shrines, especially in those dedicated to Demeter, and at Chalkis a large number had been deposited on and around what is thought to have been a house altar.¹²¹



Fig. 44. Miniature no. 15.

¹¹⁶ Kotitsa, 151, no. Ep1*; H. Andreou, *AD* 35 (1980) B'1, 306, τάφος 10 no. 2, pl. 148δ.

¹¹⁷ Σ. Δρούγου and Γ. Τουράτσογλου, *Ελληνιστικοί λαξευτοί τάφοι Βεροίας* (Athens 1980), 140-41, figs. 28-30.

¹¹⁸ J.N. Coldstream in *Knossos KPH*, 35.

¹¹⁹ Π. Θέμελης, in *Γ'ΕλλΚεQ*, 148, pls. 86-87.

¹²⁰ Kurtz and Boardman, 209.

¹²¹ See S. Houby-Nielsen *et al.* in *TPR*.

At Metapontum, miniatures were first associated with child burials,¹²² and later with women's participation in religious rites at local sanctuaries.¹²³ By the late fourth century B.C. miniature vessels seem to have "virtually disappeared".¹²⁴

Lamps

Lamps are a common feature in Greek and Roman burials. Just as vessels for drinking and eating accompany the dead, not for their intrinsic value as gifts, but for the meal they signify, the presence of lamps should be interpreted on a symbolical level. The perfumed smoke from the lamp contrasts with the smell from the decaying corpse and it functions thus as a purifier. On the other hand, the lamp could be seen not so much as a device to produce light but on the contrary as a symbol of the night and the realm of the dead in contrast with that of the 'real world' of daylight.¹²⁵

There were four lamps in the grave (Figs. 45-46, 48-50). Each is different from the others, both as regards shape and fabric, so it is easy to believe that they were deposited at different times, and tempting to suggest that each lamp should be associated with one of the four burials in succession. The lamps are however all relatively close in date, making it difficult, not to say impossi-

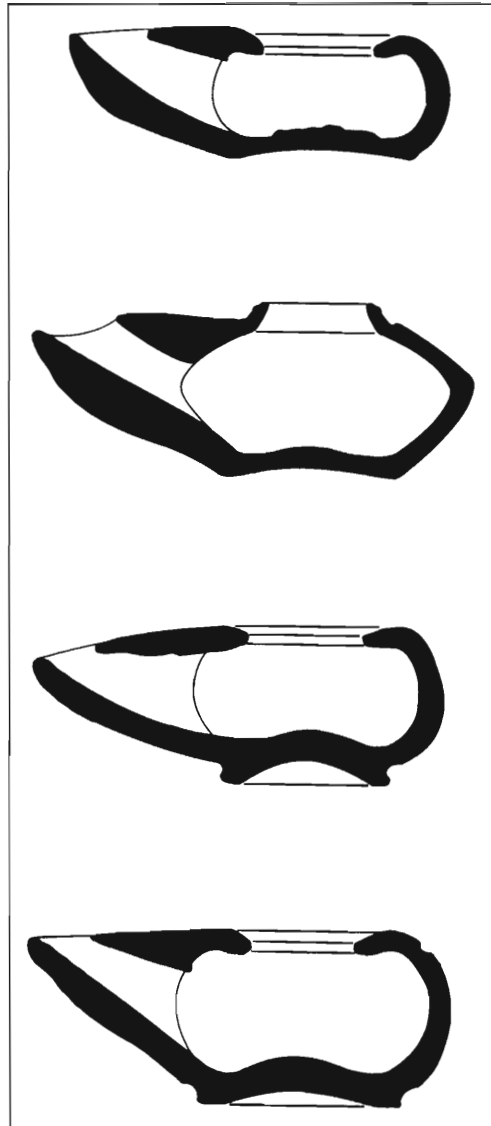

Fig. 45. Lamps, nos. 16-19.

ble, to determine the relative order of their deposition by stylistic criteria.

Virtually every archaeologist who has published lamps from a given excavation has presented a new typology, unique to that site. One of the first was

¹²² Fifth century B.C.: *Metaponto*, 189.

¹²³ *Ibid.*, 196.

¹²⁴ *Ibid.*, 229.

¹²⁵ For a recent discussion of the subject : V. Bel, *Pratiques funéraires du Haut-Empire dans le Midi de la Gaule* (Lattes 2002), 145-46.

Oscar Broneer, who published the lamps from Corinth in 1930. His typology was in general use as a reference system until it was superseded by Richard Howland's publication of the lamps from the Athenian Agora in 1958. In some ways it is easier to refer to Broneer's earlier classification: his groups are larger than Howland's, and consequently fewer. Broneer divided the Greek wheel-made lamps into 17 groups, compared with Howland's 37, not counting 'sub-' and 'sub-sub-groups'. When applying these typologies to lamps with a different origin, i.e. neither Corinthian nor Attic, only general resemblances can be said to have chronological relevance, and a system with few but large typological groups is then easier to handle than one with a fine grid. Broneer also included both Corinthian and imported lamps in his system, which to some extent gives it broader validity. Typologies published later than Broneer's and Howland's are generally site-specific and based on either, or both, of the two earlier ones.¹²⁶

Being readily classified into types following a chronological development, lamps are very important as dating instruments, and occur in most Classical and Hellenistic contexts, whether funerary, domestic or ritual. The lamp sequences as established at the Athenian Agora and Corinth were based on independently dated contexts, but one should bear in mind that lamps, in most cases, cannot give a narrower margin

than half a century, particularly as far as regional productions are concerned. A significant chronological delay will also have occurred when a certain type was copied in a new region: fashions, as we very well know, lag behind more at some places than at others.

Of the four lamps in the grave, two are easily identified as types in Broneer's classification, viz. VII (no. 16, Fig. 46) and IX (no. 17, Fig. 48). The two remaining lamps (nos. 18 and 19, Figs. 49-50) are simplifications of Corinth type VII, or, if one prefers, descendants of type VI, current in the Classical period.¹²⁷

All the lamps from the grave had burning marks on the spout and had thus been used prior to their deposition. This is another indication of regional differences in Hellenistic burial customs, since, to name an example, none of the lamps in over 200 Hellenistic graves at the North Cemetery of Knossos had signs of having been used. Many were, indeed, haphazardly manufactured and poorly fired, apparently without any ambition towards durability.¹²⁸ The lamp in the Trichonio grave had, like the Chalkis lamps, signs of usage.¹²⁹

A characteristic feature of Greek lamps after the end of the Classical period is the development of a shoulder creating a narrower filling hole than previously. The profiles of our four lamps are in this sense clearly within the Hellenistic tradition. Three of them adhere to the

¹²⁶ A discussion of the Corinth, Agora and Kerameikos typologies: Blondé, *Thorikos*, 19-27.

¹²⁷ *Corinth* IV,2, 43-49.

¹²⁸ *Knossos KPH*, 127.

¹²⁹ *Trichonio*, 324, pl. 163γ.

basic Classical type with a rim sloping inwards around the filling hole; one, however, represents a new type, created in the late fourth century, with a rising, collared rim.

It should be noted that all the lamps also have a smooth underside, meaning that the slightly concave underside has been polished, and slipped, before firing. This is of some chronological significance since, later in the Hellenistic period, lamps are often taken straight from the wheel leaving string marks underfoot.

By comparison with the standard publications from the Athenian Agora and Corinth, the lamps can all be broadly dated within the time-frame of the last quarter of the fourth century and first half of the third. Additional dating evidence is also provided by several parallels from more recent excavated fourth to third century contexts at Eretria on Euboea.

16. F99-5049. GR3/3. Lamp, wheel-made. Complete, handle missing. DR 4.1; filling hole 2.3; DB 4.0; H 3.7; Length 8.9. Fine, reddish buff fabric (7.5YR 7/6) with small grey inclusions. Brown slip inside, out and underfoot; thinly applied and mottled. Broad rim sloping inwards, grooved at junction with wall. Attachments preserved of raised horizontal strap handle. Groove at junction of wall and shoulder. Disc foot separated from body by undercutting. Recessed base, raised floor inside. Used.

This lamp (Fig. 46) is of Broneer's type VII,¹³⁰ differentiated, in his system, from the more common type VI, by a groove separating the rim from the wall. The latter had been the dominating



Fig. 46. Lamp no. 16.
Photo: H. Frost.

lamp-type in the fifth century, and the grooved variety also occurs for the first time in that century, but enjoys greater popularity in the following and continues in production at least until the early third century. Characteristic of the type are a broad inward-sloping rim, nearly vertical wall, and the recessed base with rising floor. The type was more common in Attica than at Corinth.¹³¹

It is most often handle-less, but is also made with a raised horizontal strap handle. The horizontal handle goes out of fashion at Taras already in the fourth century, and is replaced by a vertical ring handle placed on the shoulder. This vertical handle appears only occasionally on Classical lamps but is, at Corinth, the most common form of handle in the Hellenistic period.¹³² In the Early Hellenistic period the type also appears with a small lug handle

¹³⁰ *Corinth* IV,2, 45-46.

¹³¹ *Agora* IV, 66-80, types 24 C, 24 C', 25 A, 25 B, 25 B', 25 D'; Blondé, *Thorikos*, 99-113, nos. 142-85.

¹³² Or indeed *only*: *Corinth* IV,2, 7.

on one side (as on the type-IX lamp, no. 17, Fig. 48). The horizontal handles also disappear fairly early at Athens,¹³³ but continue in vogue elsewhere in the Greek world until the Late Hellenistic period.¹³⁴

The only lamp present in the Trichonio grave is of this type (Fig. 47).¹³⁵ It has a lug handle on the right hand side, but is in other respects close to the Chalkis lamp. It is said to be “probably of Corinthian workshop”: somewhat surprisingly, since Broneer stated that there were very few locally produced type-VII lamps at Corinth.¹³⁶

For the date of our lamp, apart from the standard publications of Athens and Corinth, one may refer to a more recently published lamp from Eretria, found in a context dated in the late fourth century or the first half of the third.¹³⁷

The type appears in Macedon in the last decade of the fourth century and enjoys relative popularity during the first half of

the following century. Characteristic of many of the Macedonian lamps of this type is their lack of articulated foot, which sets them apart from our example.¹³⁸

17. F99-5046. GR3/3. Lamp, wheel-made, with lug handle. Complete; handle chipped, surface poorly preserved. DR 2.3; filling hole 2.0; DB 3.6-3.8; H 3.6; Length 9.3. Medium, hard fired, reddish yellow fabric (5YR 6/8). Very gritty to the touch and cracked. Red to brown slip inside, out and underfoot; worn and flaking. Raised, collared rim separated from shoulder by groove. Biconical body profile: sloping shoulder to carinated widest diameter; lower wall sharply flaring outwards. Perfunctory groove on lower wall. Semi-circular lug handle attached to shoulder on right hand side.¹³⁹ Narrow spout. Slightly recessed base with smooth underside, raised floor inside. Fabric and slip alien and not comparable to any other vessels in the grave. Used.

This lamp (Fig. 48), apparently an import, is classified as Broneer’s type IX. However not as common as type VII, it is a fairly widespread type in the early third century,¹⁴⁰ so the two types overlap rather than belong to chronologically successive phases. Type IX is characterized by a groove around the

¹³³ Although still occurring on “*rétardataire* specimens” into the third century: *Agora IV*, 97-98 no. 420, pls. 15, 41.

¹³⁴ Crete: *Knossos KPH*, 127, Fig. 3.17:t (2nd cent.); J. Eiring, in *E’ΕλλΚεQ*, 59, pl.30c (late 2nd/early 1st cent.).

¹³⁵ *Trichonio*, 324, pl. 163γ.

¹³⁶ *Corinth IV*, 2, 46.

¹³⁷ *Eretria X*, 183 no. 39, Fig. 223: from building phase 2, dated late fourth or early third cent. (*op.cit.*, 42); “*Haus I, Raum n/u, Fundkomplex 1882, späteres 4.-1. Hälfte 3. Jh.*” *op.cit.*, 202.

¹³⁸ Σ. Δρούγου (ed.), *Ελληνιστική κεραμική από τη Μακεδονία* (Thessalonica 1991), 70-71 no. Veroia Π 2665, pierced lug-handle, mid-fourth to early third cent.; *v. autem*: «*Χρονολογικός πίνακας σχημάτων*», type VII.

¹³⁹ The same side as Broneer calls the left (*Corinth IV*, 2); in any case, ‘starboard’ if the lamp is seen as a ship and the spout its prow. The lug handle is generally placed on this side.

¹⁴⁰ Among more recently published examples can be mentioned, from Crete: Π. Δροσίνου, in *E’ΕλλΚεQ*, 38-40, τάφος 2, no. Π 6830, pl. 17γ-δ. Grave dated by the lamp (late fourth to early third century, *v. p.* 39); Thessaly: Μ.-Φ. Παπακωνσταντίνου, in *E’ΕλλΚεQ*, 336, pl. 167b no. Κ 6378, type EX1; Middle East: E.P. Ζοϊτοπούλου and J.M. Fossey, *La collection des antiquités gréco-romaines de l’Université McGill I, Les lampes gréco-romaines* (1992), 29 no. 5, fig. 6, pl. 1.

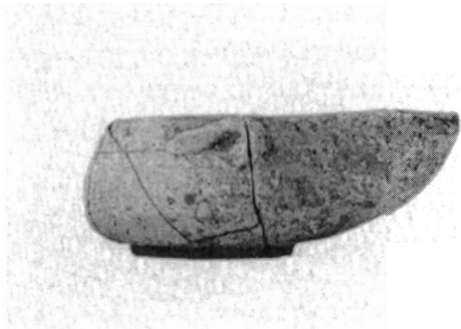

Fig. 47. Lamp from Trichonio. *Trichonio*, pl. 163A.

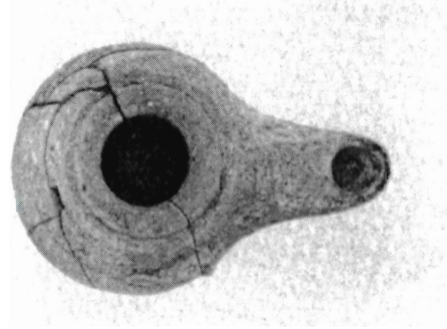

Fig. 48. Lamp no. 17. Photo: H. Frost.

(often raised) rim of the filling hole. The profile is angular at varying degrees forming a 'watch-like' or biconical shape. The underside, generally recessed, is always smoothed.

The early lamps of this type have no handle, but often sport a little pierced lug on the side.¹⁴¹ The pierced lug led to an early theory that the lug handle was devised to store the wick needle when not in use, but since many lugs, as in our case, are not pierced, it could equally have been conceived as a finger support. Yet again, the lug also appears on lamps with proper handles, and cannot then have served any real purpose.¹⁴² The question remains whether the piercing or not of the lug has any chronological, as well as practical, significance: it seems as if the pierced lug generally appears on the early lamps, implying that the hole initially may have had some, later abandoned, function.

The angular profile is best paralleled with a lamp from Athens, found in a context dated in the first quarter of the third century B.C.¹⁴³ Our lamp has a



wider spout, less clearly a separate entity from the body, and a slightly wider filling hole. Our lamp differs from the Attic example in that it lacks an articulated base. The same, in some cases rather tall, foot is seen on a group of lamps in the British Museum from Kalamnos, said to be of local manufacture.¹⁴⁴ It may be worth noting that roughly half of these carry a lug on the right hand side while the others remain entirely without a handle.

A type IX lamp with a rather larger diameter and shorter spout came from the

¹⁴¹ e.g. *Agora IV*, pl. 41, no. 397.

¹⁴² *Corinth IV*, 2, 6-7.

¹⁴³ *Agora IV*, 95 no. 410, pls. 14, 41. Type 29 A.

¹⁴⁴ *BM Lamps I*, 189-90 nos. Q 437-41.

Fig. 49. Lamp no. 18
Photo: H. Frost.



third-century Eretrian well deposit already mentioned.¹⁴⁵

18. F99-5057. GR3/3. Lamp, wheel-made, without handle. Complete. DR 3.8; filling hole 2.4; DB 3.4; H 3.3; Length 8.8. Fine, soft pinkish cream fabric (7.5YR 8/4). Brown to dark grey slip inside, out and underfoot; worn off at resting surface. Pitted surface. Broad rim sloping inwards, carinated at the highest point. Groove separating foot and wall. Recessed disc base, raised floor inside. Used.

This type of broad-rim lamp without a groove (Fig. 49) has its origin in Broneer's type VI of the Classical period, and is a later development of Howland type 23 C of the first half of the fourth century.¹⁴⁶ Good parallels have been found at the Kerameikos, although the type, in its Attic version, is regarded as obsolete after the middle of the

fourth century.¹⁴⁷ The type was widely produced, and stylistic similarities can therefore only be said to have chronological validity in a very broad sense.

The general trend in lamp-manufacture in the second half of the fourth century B.C. – towards a narrower filling hole and a taller and more angular profile – is reflected by a lamp from Isthmia.¹⁴⁸ The base of our lamp is also more constricted by a deeper undercutting of the wall than on the earlier Attic examples and on the Corinthian lamp at Isthmia.

The presence of a groove, defining the rim from the wall, differentiated Broneer's type VII from type VI (and its descendants), but that the groove may have been an arbitrary addition is illustrated by some lamps from Cnidus, in the British Museum, some with, others without, a groove, but in other respects very similar.¹⁴⁹ The profiles of the Cnidian lamps are close to our (grooveless) lamp, not in itself evidence of a particular connexion between Western Greece and Asia Minor, but rather a result of the dissemination of a popular type, which has resulted in superficial resemblances in style over a large area. The Cnidian lamps are mentioned here by way of an example: further comparisons can no doubt be found in many other Greek regions.

¹⁴⁵ S.G. Schmid, *E'ΕλλΚεο*, 361-63, 368, pl. 189 no. 76.

¹⁴⁶ *Agora IV*, 59-60, nos. 228-33, pls. 8, 36.

¹⁴⁷ *Kerameikos XI*, 24-25 nos. 64-70, pls. 14-15. Type RSL 2: 'Rundschulterlampen mit glattem Rand, geschlossener Körper', fourth to third century B.C. 'Spätere [than the early fourth cent.] Rundschulterlampen mit glattem Rand ... sind für ihre Zeit rückständig; ihre Datierung bleibt entsprechend unsicher.'

¹⁴⁸ *Isthmia III*, 14 no. 87, pls. 2, 16.

¹⁴⁹ *BM Lamps I*, 132-33 nos. Q 259-62, pl. 45.

For an approximate date we can refer to two lamps with a comparable profile (but shorter spout) at Eretria, from levels dated in the late fourth or early third century.¹⁵⁰ These are equipped with a horizontal handle, while other lamps of the same type carry the little lug handle on the side.¹⁵¹

19. F99-5040. GR3/3. Lamp, wheel-made, without handle. Complete. DR 3.6; filling hole 2.3; DB 3.8; H 2.7; Length 8.1. Medium, soft yellowish pink fabric (5YR 7/6). Thinly applied, mottled red to brown slip inside, out and underfoot. Pitted exterior surface. Heavy in relation to size. Broad rim sloping inwards, carinated at highest point. Squat profile. Groove undercutting wall at base. Slightly recessed and smoothed underfoot. Alien fabric. Used.



Fig. 50. Lamp no. 19.
Photo: H. Frost.

This lamp (Fig. 50) has no articulated foot, but only a slightly recessed base. With a rather squat profile it is in other respects very similar to the pervious lamp (no. **18**, Fig. 49). This simple version is not to be found among Broneer's types at Corinth or Isthmia, and does not seem to have been current at Athens either. There, Howland's "Inkwell" type, of the second half of the fourth century, has a much more erect and taller wall, and sharper demarcation of the inward-sloping rim.¹⁵² Elsewhere the type is very common and is to be

considered a regional type and simplification of an earlier, Classical model.

Examples of a similar fashion are to be found in Northern Greece. A stylistically more developed example, with longer spout and smaller filling hole, comes from Macedonian Pella,¹⁵³ whereas our lamp corresponds quite well with a locally produced group of lamps at Pherae in Thessaly, found in contexts dating from the last years of the fourth to the middle of the second century B.C.¹⁵⁴

¹⁵⁰ *Eretria* X, 197, nos. 441-42, fig. 246: building phase 2.

¹⁵¹ *Taranto* II,1, 106 no. 43.61 (From a non-identified grave dug in 1933 at Ginosia; stylistic date: second half of fourth to first half of third cent. B.C.).

¹⁵² *Agora* IV, 61 no. 236, pls. 8, 37, type 23 D.

¹⁵³ Σ. Δρούγου, *Ανασκαφή Πέλλας 1957-1964. Οι πήλινοι λύχνοι* (Athens 1992), 60 no. 114, Fig. 8, pl. 28 (type ΠΛ9).

¹⁵⁴ Α. Δουλιγέρη-Ιντζεσίλογλου, in *Γ'ΕλλΚεΘ*, 368-69, pls. 276, 284-85 (type ΦΕ1).

Terracotta Figurines

The so-called *Tanagra figurines*, generally between 15 and 25 cm high, represent women of various ages, most often quite young and pretty, standing in an elegant *contrapposto*: “demure ladies in their Sunday best”.¹⁵⁵

The ‘Tanagras’ have their name from the ancient site in Boeotia, where a large number of these figurines came to light through illicit excavations in the first years of the 1870s.¹⁵⁶ On account of the sheer quantity of figurines unearthed, augmented by official excavations undertaken by the Greek Archaeological Society a few years later, they were originally thought to have been produced in Boeotia. Subsequent activities at the Athenian Agora, revealing large numbers of figurines as well as moulds, gave birth to the idea of an Attic production. The ‘Coroplast’s Dump’, a pair of pits with discarded figurines from the late fourth century, produced examples whose style was taken to presage the ‘Tanagras’.¹⁵⁷ Dorothy Thompson thought that the style had emerged in Athens during the fourth century B.C. with inspiration, in the choice of characters, from New Comedy.¹⁵⁸

That is not to say that all of the figurines found at Tanagra were made in Athens: there was indeed a local production in Boeotia, just as at many other sites

around the Mediterranean, but it had taken its lead from Athens, at that time still a leading centre in the art of clay-working and, with its position as cultural metropolis, a more likely source than rural Boeotia for the imagery displayed in the terracottas. The Attic figurines were normally made from two moulds, front and back, and frequently without vent at the back. Local Boeotian figurines were produced in a sandy, soft, yellow to reddish fabric, from a front mould only. The back was unmodelled, most often with round or square vent. They generally carried a thick, chalky-white slip with additional colours.¹⁵⁹

The term ‘Tanagras’, in its narrow sense, covers only the Early Hellenistic figurines found in Boeotian graves and constitutes a small class, including female figurines, children with a few boys, and erotes – essentially winged children – but otherwise no deities.¹⁶⁰ When applied with a broader meaning, the term takes in stylistically related figurines from many parts of the Hellenistic world in the late fourth and third centuries, in particular Asia Minor, Alexandria and Southern Italy.

Figure: standing woman with hat

20. F99-5045. GR3/3. Figurine. Almost complete, in nine fragments: lower part of right arm and part of hat missing. H 13.4. Base 5.1 x 3.5. Fine red fabric (~5YR 5/6) with voids from

¹⁵⁵ J. Boardman in J. Boardman, J. Griffin and O. Murray (eds.), *Greece and the Hellenistic World* (Oxford 1988), 388.

¹⁵⁶ *Coroplast’s Art*, 48-49.

¹⁵⁷ D.B. Thompson, *Hesperia* 21 (1952), 120-21.

¹⁵⁸ D.B. Thompson, *AJA* 70 (1966), 56, 62.

¹⁵⁹ *Coroplast’s Art*, 49.

¹⁶⁰ D.B. Thompson, *AJA* 70 (1966), 52.



Fig.51. Terracotta figurine no. 20: a) left profile, b) frontal, c) right profile, d) back. Photo: H. Frost.

lime eruptions. Traces of self-slip on back. Traces of white paint on body and clothes, blue on hat. Standing female with hat. Composed of three parts: hat, figure, rectangular base plaque. Dressed in chiton and himation. Head tilted to right. Hollow, open at back.

The first figurine from the grave is a delightful and rather small woman – only thirteen centimetres tall – dressed in hat, long himation and chiton (Figs. 51-52).¹⁶¹ She stands on her right leg; the left being the *Spielbein*, with the foot brought forward and emerging from underneath the chiton. Her stance is a variant of the ‘Sophocles pose’, after the portrait-statue in the Vatican Museum.¹⁶²



Fig. 52. Terracotta figurine no. 20, detail of head. Photo: H. Frost.

¹⁶¹ J. Laver, *Costume in Antiquity* (London 1964), p. 94, nos. 4 and 6.

¹⁶² G.M.A. Richter, *Portraits of the Greeks*, rev. ed. (London 1984), 206-09, Fig. 170.

Her hair is arranged in the so-called melon hair-style.¹⁶³ On it, she wears a wide, conical sun hat, resembling a Vietnamese rice-farmer's straw hat, and not unusual on the Tanagra statuettes. Often, however, the himation is worn over the head, with the hat pinned on top (Fig. 53).¹⁶⁴ A rather well-known

figurine in Berlin has a stance resembling our figurine's, and a round, pointed hat on top of the himation, which is pulled over her head.¹⁶⁵ She is, however, twice as tall as the Chalkis woman, and in contrast to ours, the *Standbein* is the left leg, *Spielbein* the right. She furthermore has a tall, slender body with a sinewy expression and the exaggerated *contrapposto* characteristic of the Attic Tanagras. Our statuette is, by comparison, quite a chubby woman.

As with so many of the finds from the grave, the surface of our figurine is badly damaged, so that the slip, which was the same colour as the clay and served as foundation for the paint, has been largely worn off and is only preserved on the otherwise unpainted back. Traces of paint are visible on the dress and body (white), and on the hat (blue).

The head is comparable to one found at Isthmia, albeit with the head turned the other way, dated in the early part of the third century (300-270 B.C.).¹⁶⁶

Figurine: girl holding net and ball (or wreath and apple)

21. F99-5008. GR3/3. Tanagra figurine. Complete in two fragments. H 16.2. Fine, unevenly fired yellowish red to reddish buff fabric (5YR 5/8 - 7.5YR 7/6). Worn surface, especially on right shoulder. Pale blue slip preserved in patches. Pink paint on flesh; blue on rope;



Fig. 53. Terracotta figurine of woman wearing himation. *BM Terracottas* III, no. 2068.

¹⁶³ G. Kleiner, *Tanagrafiguren. Untersuchungen zur hellenistischen Kunst und Geschichte*. (2nd ed., K. Parlasca and A. Linfert) (Berlin 1984), 15; Higgins, *Tanagra*, 122, Fig. 143a-b.

¹⁶⁴ Boston, MFA, 01.7843, height 24.5 cm: *Coroplast's Art*, 112, no. 5; BM cat. C 312, height 19 cm: R.A. Higgins, *Greek Terracottas* (London 1967), pl. 42 = *BM Terracottas* III, 51 no. 2068, pl. 13.

¹⁶⁵ Berlin inv. TC 6314, height 27 cm: *Tanagra und Ephesos*, pl. 16; *Bürgerwelten*, 87, no. 5.

¹⁶⁶ V.R. Anderson-Stojanović, *Hesperia* 65 (1996), 81-82, no. 37, pl. 24.



Fig. 54. Terracotta figurine no. 21: a) left profile, b) frontal, c) right profile, d) back.
Photo: H. Frost.



Fig. 55. Terracotta figurine no. 21, detail of head. Photo: H. Frost.



Fig. 56. Terracotta figurine no. 21, detail of toys. Photo: H. Frost.

white on chiton; red on hair. Standing girl, resting on left leg, right leg forwards. Holding ball between right hand and hip, a rope or net folded over left wrist, fist clenched. Hollow figurine, square opening carved in back. Fingerprints on surface.

The best preserved – and perhaps prettiest – of the figurines from the grave is a girl holding her toys (Fig. 54-56). She is wearing a chiton without a cloak. Her hair is arranged in a melon coiffure, tied rather high on the skull in a child-like way.¹⁶⁷ Her chubby face and limbs, and the lack of breasts, betray her age to be between, say, six and ten years – at the very most twelve, which, in Greek Antiquity, is when prepubescence was considered to end.¹⁶⁸

What the toys are can be debated: a ball and what at a first glance looks like a thick rope, but more probably should be interpreted as a net, folded over her wrist (Fig. 56). It is the age of our girl, which would lead to that conclusion: ball and net forming a set of toys. However, a mature woman, the above-mentioned hatted figurine in the British Museum (Fig. 53), holds a similar object – i.e. a coil of clay, pricked to give a rough surface. She holds what was initially described by Reynold Higgins as a “woollen fillet”¹⁶⁹ tied together at the ends. In the book *Tanagra and the Figurines* Higgins showed how it was more likely a wreath of dried flowers, like those found preserved in Roman graves at Hawara in Egypt.¹⁷⁰ A wreath would make sense in our case too, but then the round object should be a fruit, and not

¹⁶⁷ Higgins, *Tanagra*, 122-23, Fig. 143c.

¹⁶⁸ I am grateful to Lesley Beaumont for this and other comments concerning the figurine.

¹⁶⁹ R.A. Higgins, *Greek Terracottas* (London 1967), pl. 42.

¹⁷⁰ Higgins, *Tanagra*, 123, fig. 144, also figs. 140, 162; *BM Terracottas III*, 51 no. 2068, pl. 13.

a ball. There is no indication of an apple's stem or the dry remains of the flower which hang on to a pomegranate, and the interpretation of it as a ball is perhaps the most appropriate one: the 'rope' or 'wreath' then becomes – in all likelihood – a net.

The ball is sometimes a gift offered by girls to Persephone, and in other depictions the goddess herself is seen holding a ball.¹⁷¹ On a pinax from Locris a woman is offering a rooster and a round object to a seated goddess: the round object has sometimes been interpreted as an apple or pomegranate, but is more likely a ball.¹⁷² In fact both balls and pomegranates were offerings to Persephone and had as such a funerary connotation. Balls also relate to marriage, and girls were known to dedicate toys to goddesses in Antiquity before marriage.¹⁷³

The presence of balls in funerary contexts could then be explained by “cases of girls who died unmarried, and for this reason had a ball buried with them as a symbol of their unfulfilled destiny”.¹⁷⁴ It is certainly a thought worth considering, but it depends whether we see the figurine as representing a girl with objects, whose connotation should be considered significant, or as a toy in itself, which was put in the grave only because it happened to belong to the dead girl.

Figurine: enthroned woman

22. F99-5036. GR3/3. Figurine of seated female. Neck to base in four fragments. H 8.9; W 4.1. Soft, crumbly strong brown to reddish buff fabric (7.5YR 5/6 - 7/6), badly fired. Scant traces of white/pale paint; worn, eroded surface. Seated female figure on throne. Head and front part of throne missing. Hollow; rectangular vent in back 1.8 x 2 cm. Animal vertebra found with figurine.

The figurine of a woman seated on a throne is very fragmentary as well as worn, so much so that it can be difficult to make out what the figurine originally represented (Fig. 57). The surface is badly damaged and no traces of colouring are preserved. The head and parts of the throne are missing. The composition resembles that of a Tanagra statuette found in a grave at Taras.¹⁷⁵ Dressed in a chiton and himation, she is sitting on a rock rather than a throne. Her left arm rests on the rocks, while the left is covered by the folds of the himation in her lap. Graepler dates the Tarentine statuette in the first quarter of the third century (phase B2), although the rest of the assemblage in this very rich grave is given a later date (phase D, 225-175 B.C.).¹⁷⁶

Our figurine seems to hold her right arm, covered by the mantle, over her chest with the hand on the left shoulder. The gesture can be compared with that of standing women, e.g. a veiled, dancing woman from Taras.¹⁷⁷ A still closer par-

¹⁷¹ M. Dillon, *Girls and Women in Classical Greek Religion* (London 2002), 223-25.

¹⁷² G. Pugliese Carratelli (ed.), *The Western Greeks*, (Venice 1996), 700, pl. 166.3.

¹⁷³ *Ant. Pal.*, VI,280 (to Artemis).

¹⁷⁴ C. Sourvinou-Inwood, *JHS* 98 (1978), 108.

¹⁷⁵ Graepler, 205, fig. 198, no. 46.10 (phase D).

¹⁷⁶ Graepler, 111 n. 223.

¹⁷⁷ Graepler, 222, fig. 247.

Fig. 57. Terracotta figurine
no. 22.
Drawing A. Hooton.

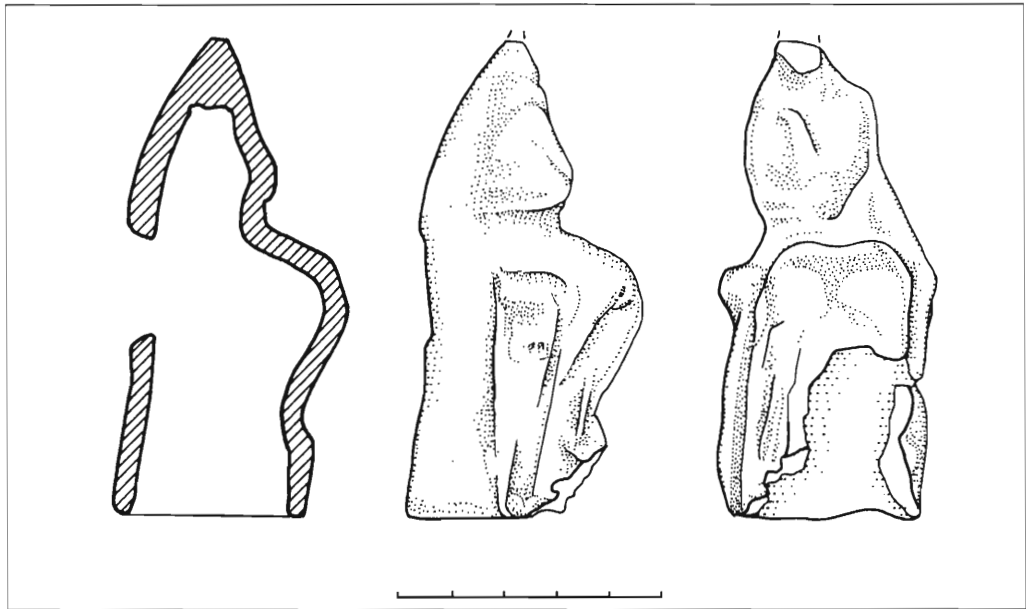

allel is a Tanagra figurine in Berlin: a young woman sitting on rocks, her right arm under her garment. She looks at a dove perched on her left shoulder.¹⁷⁸

Head of figurine

23. F99-5064. GR3/3. Head from terracotta figurine. One fragment. H 2.7; W 2.4; Thickness 1.7. Fine, soft brownish pink fabric (5YR 6/6) with small grey inclusions. Traces of red paint on a white foundation slip at the back of the head. Very worn face and hair. Next to it was found a – not restorable – fragment of its body (F99-5050).

This head (Fig. 58) is so poorly preserved that not much can be said about it, more than to give its measurements and to register the fact that, with a part of the body in an even worse state of preservation, it brings the number of figurines in the grave to four, not counting the doves.

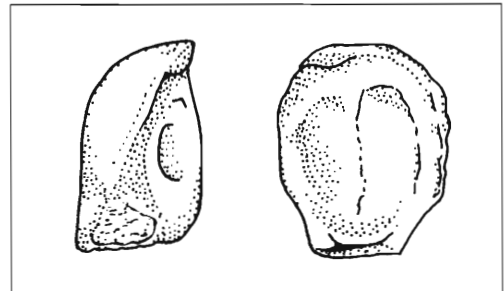

Fig. 58. Head of figurine no. 23. Drawing A. Hooton.

Dove figurines

24. F99-5016. GR3/3. Terracotta figurine of dove. Restored from three fragments. Beak missing. DB 3.9; H 8.9; Length, head to tail 12.5. Fine, soft reddish yellow fabric (5YR 6/8). Traces of white or pale paint on body and pedestal base, flaking. Folded wings, fan tail.

25. F99-5063. GR3/3. Miniature dove figurine. Chipped, base missing. H 1.7; length 3.1. Fine, yellowish red fabric as dove figurine F99-5016. Traces of white paint. Found in kantharos (see no. 2).

¹⁷⁸ *Tanagra und Ephesos*, pl. 5.



Fig. 59. Terracotta figurine from Tarentum, Graepler, 204, fig. 195.

That the dove was a symbol of the goddess Aphrodite – and of other deities such as Eros – is rather splendidly illustrated on a terracotta group from Tarentum, which has the naked goddess kneeling in front of a cockle shell with Eros sitting on her shoulder and a dove on her outstretched hand (Fig. 59).¹⁷⁹ When present in Hellenistic imagery the dove’s “general message must be one of love, success in love, good fortune, and happiness”.¹⁸⁰ The bird frequently occurs in connexion with, or as an attribute to, Tanagra figurines,¹⁸¹ and is then a specifically female symbol, sometimes seen with young girls.¹⁸²

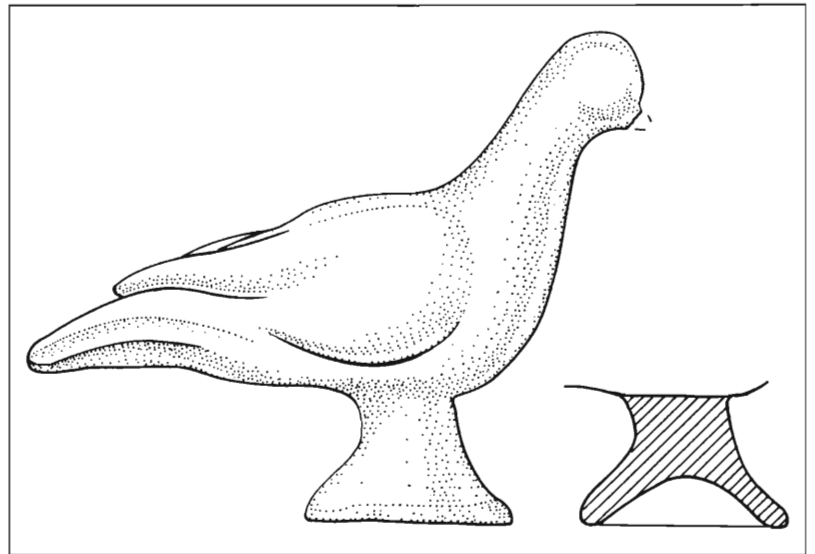

Fig. 60. Terracotta figurine no. 24. Drawing: A. Hooton.



Fig. 61. Terracotta figurine no. 24. Photo: H. Frost.

¹⁷⁹ Graepler, 282, no. 196.6; 204, fig. 195; Another goddess assuming Aphrodite’s symbols by association is Persephone, at Locris: *Metaponto*, 773; (see also C. Sourvinou-Inwood, *JHS* 98 (1978), 101-21.

¹⁸⁰ J.R. Green, in *Studies in Honour of J. Basil Hennessy* (1995), 274.

¹⁸¹ Berlin, TC 6689: *Bürgerwelten*, 88, no. 6; pl. 16 no. 2089.

¹⁸² Berlin, TC 8873: L. Summerer, *Hellenistische Terrakotten aus Amisos* (Stuttgart 1999), 116, pl. 50, no. S IV 24.

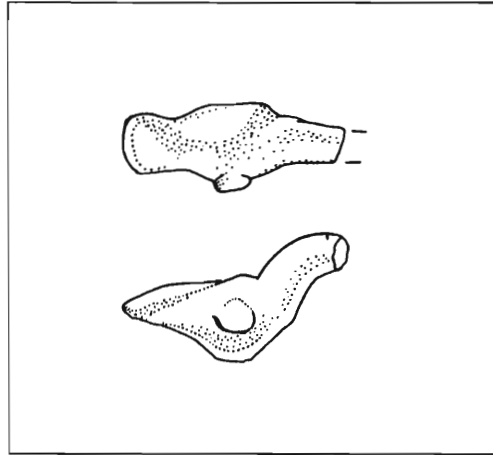

Fig. 62. Miniature figurine no. 25. Drawing: A. Hooton.



Fig. 63. Gold ring no. 26. Photo: H. Frost.

Clay figurines of doves are, on the other hand, also seen as a child attribute along the lines with other toys.¹⁸³

The large dove, no. **24** (Figs. 60-61), was found in the north-west corner of the grave, whereas the miniature no. **25** (Fig. 62) was found not far from it, inside one of the kantharoi (no. **2**) together with four potsherds and animal bones (Fig. 13).

A fragmentary bird with circular base was found, with shells inside a lebes gamikos, in a child grave at Metapontion, dated in the early fourth century B.C.¹⁸⁴ That bird is smaller than no. **24**, although not a miniature as no. **25**. The smaller, and rather more rudimentary, dove has a fairly close parallel, allegedly from the vicinity of Smyrna, which is now in the British Museum.¹⁸⁵

Metal objects

Gold ring

26. F99-5066. GR3/5a. Gold seal ring. Complete. D 1.4; Seal oval 0.9 x 0.6, flat, 0.1 thick. Open ring. Winged Nike holding wreath in right hand.

The only ring in the grave does not, albeit of gold, represent a high point in the art of Greek goldsmiths: it is composed of a very thin, open band, which broadens to an oval plaque with the rather crudely carved figure of a Nike holding a wreath (Fig. 63).

Rings from the same period, but of generally much better quality, have been found in Tarentine graves. An example is a gold ring from the late fourth century showing, in an oval, a standing woman holding a wreath in her left

¹⁸³ "Von den Terracotta-Vögeln (...) könnte allenfalls die Taube als Kinderattribut gedeutet werden. Eher ist jedoch zu vermuten, daß Tauben in den weiblich-hochzeitlichen Bereich gehören.", Graepler, 174 n. 192.

¹⁸⁴ *Metaponto*, 785 no. T330-20.

¹⁸⁵ *BM Terracottas III*, 152 no. 2409, pl. 73.

hand, resting her right arm on a small column.¹⁸⁶

There is always the question whether a particular piece of jewellery had been worn in life or was manufactured expressly for deposition in the grave. Pieces in the latter category are thin and not resistant to wear, such as gold leaf decoration and thin rings and bracelets. The band of our ring, however, shows signs of having been bent repeatedly over a finger, and is probably a piece of gold work one could be expected to find in a provincial centre such as Chalkis.

Rich gold finds in Late Hellenistic graves at Patrae have been taken as evi-

dence of an Achaian jewellery workshop in the second century B.C.¹⁸⁷

Beads

27. F99-5032. GR3/3. Ceramic bead covered in gold leaf. D 0.5; L 0.4.

There were, in addition, beads of several types in the grave. They are listed under the metal objects because the most elaborate ones were two biconical ceramic beads covered in gold leaf. Similar ones were found in the Derveni tombs.¹⁸⁸ Other beads from the grave were of a more simple type: small spherical, and one larger ovoid clay bead (Fig. 64).

Fig. 64. Beads, no. 27.
Photo: H. Frost.

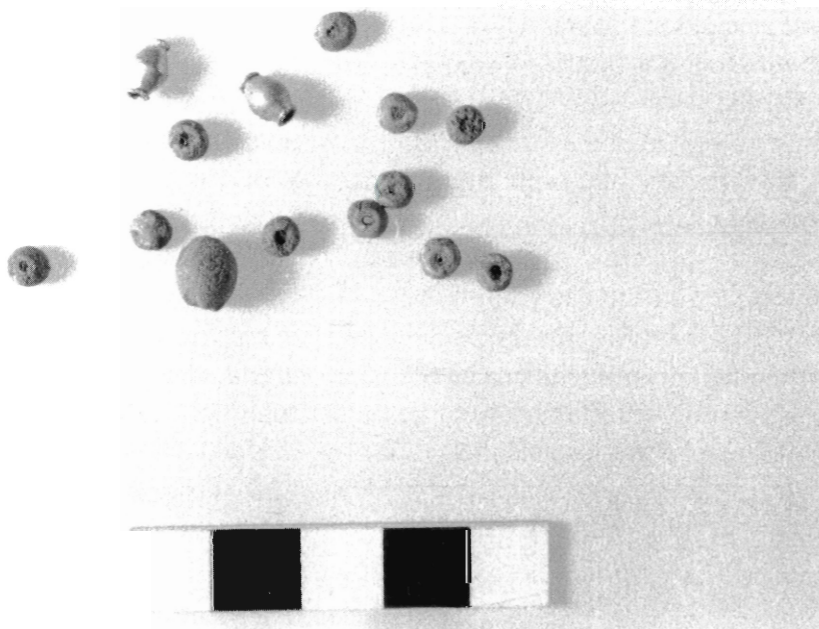

¹⁸⁶ *Taranto* III,1, 308, Fig. 242 (Taranto, inv. 22626).

¹⁸⁷ I.A. Παπαποστόλου, *AD* 32 (1977), A', 281.

¹⁸⁸ *Derveni*, 120 no. E2,, pl. 130.



Fig.65. Coin no. 28: a) obverse, b) reverse. Photo: P. Konstantopoulos.

Coin

28. F99-5033. GR3/3. Silver coin. D 0.11; Weight 0.3 gr. Obverse: horse galloping to the right; circle of dots. Reverse: Indistinct symbols. Badly preserved.

The coin is a silver hemi-obol of indeterminate mint (Fig. 65). Due to its poor condition, the representation on the reverse is not visible and it is therefore difficult to determine the emitting city. The horse on the obverse gives a clue, and it could probably be the product of a Thessalian mint. Horses are common on coins from Thessaly, which is also the origin of a number of coins from the site.¹⁸⁹ The style places it in the fourth century B.C.

(Georgia Z. Alexopoulou)

Mirror

29. F99-5034. GR3/3. Bronze mirror with lid. Restored from a total of five fragments. D (lid) 12.4; D (mirror) 12.0; Thickness 0.2-0.3; Protome H 5.1; W 5.5. Bronze Medusa head protome on lid and hinge found separately. Concentric decorative grooves on underside of lid

and mirror, and grooves around edge of mirror. Polished mirror surface. Medusa surrounded by multiple strands of hair. Part of hinge found separately (F99-5051).

The fact that mirrors (Figs. 66-70) are known in Greece since prehistoric times reveals a very basic human need to inspect the narcissistic self. The most common mirrors were handheld, consisting of a polished circular metal plate equipped with a more or less decorated shaft or handle. These, both of Greek and Etruscan manufacture, have been found in great numbers in graves and are treated extensively in the archaeological literature. Our mirror belongs to a rather lesser known, or at least less frequently studied, category: that of the so-called 'box-mirror', in German *Klappspiegel*.¹⁹⁰ It has a hinged cover to protect the polished surface and was intended to hang, as is evident from e.g. vase-paintings and tomb stones (Fig. 68).

The 'box-mirror' is the subject of a recent treatise by Agnes Schwarzmaier, *Griechische Klappspiegel*. Her book, with a catalogue of nearly 300 pieces,

¹⁸⁹ Γ. Αλεξοπούλου, in *TPR*.

¹⁹⁰ The English term is a misconception, since the mirror was not a container. The German term is altogether more appropriate.

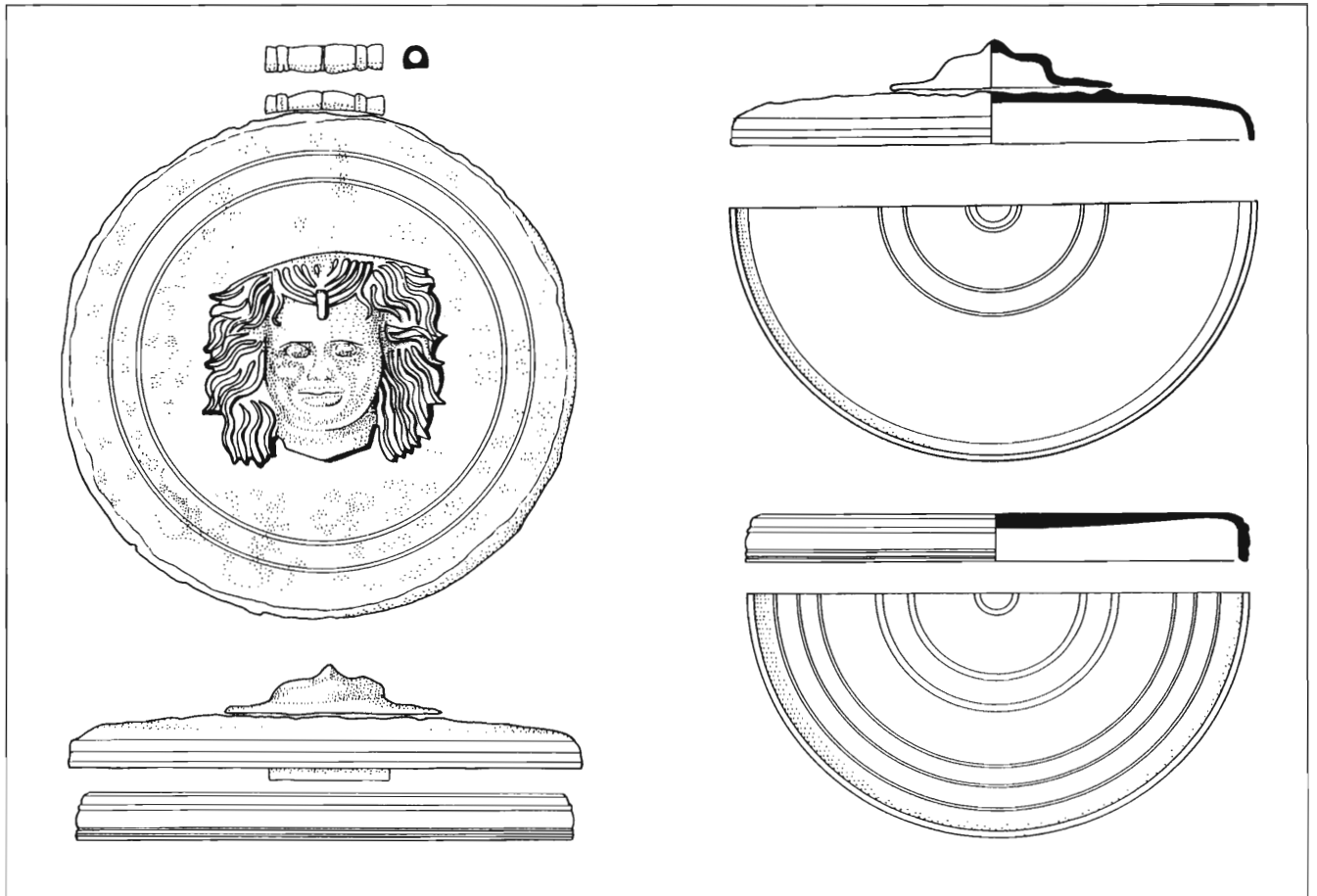

Fig. 66. Mirror no. 29.
Drawing: A. Hooton.

increases the corpus of mirrors by approximately a third from that published by W. Züchner in 1942, in a book with the same name. The mirrors extend in time over two centuries, from the early fourth to the end of the third century B.C. Schwarzmaier limits her study to mirrors with relief decoration on the lid: plain mirrors, with the same type of construction but without decoration, were current over a longer period, but are not included in her corpus.

The mirrors carried a hinge for the opening and closing, as well as a ring for suspension. No ring was found with

our mirror, but inside it was a moulded cylinder, made to attach the ring, as is evident from the indentations at both ends (Fig. 66). Sometimes additional cylinders were applied to the sides of the mirror as mere decoration and then merit the term ‘spool lugs’.¹⁹¹

The mirrors do not adhere to one linear stylistic development, but rather to several types, which vary, not only chronologically but also geographically. For dating purposes the decoration on the lid is more useful than the form of the mirror itself. Our Medusa protome (Fig. 69) finds no clear parallel in Schwartz-

¹⁹¹ *Metaponto*, 793; cf. R. Leone, in *Greci in Occidente*, 134, Reggio Calabria, Museo Nazionale, inv. 5201 and 4871. These two mirrors have identical cylinders for a suspension ring, in one case, and for suspension ring and two additional cylinders attached to each side of the mirror, ostensibly as a decoration.



Fig. 67. Mirror no. 29: a) cover, front, b) cover, back, c) mirror, front, d) mirror, back. Photo: H. Frost.

maier's corpus. The type does, however, exist in other versions. One is an early piece, dated *c.* 400 B.C., now in Berlin, with very large eyes and a stylised hair in a halo around the head.¹⁹² The other is considerably later, from the last quarter of the third century B.C., and now in Geneva (Fig. 70).¹⁹³ It shows a chubby face with a spray of thick strands of hair around it, much in the way of our example.

Perseus, the product of Danae and the golden rain, was sent by his mother's suitor, Polydectes, who thought him a nuisance, to fetch the head of Medusa, one of the three gorgons. This was a difficult task, since anyone who looked at her was turned into stone – and this was also the idea behind Polydectes' demand. With the help of the gods, Perseus succeeded in his task and, having contrived to shoot his mother's unwanted suitor by his own gun, i.e. turning Polydectes and his entourage into stone by showing them the head of Medusa, he presented it to Athena, who placed the head as an emblem on her shield. In iconography, a gorgoneion is thus an apotropaic reference to Athena. In early art, from the seventh century B.C. and onwards, the head is indeed frightening: wild, glaring eyes; a large open mouth with protruding teeth and tongue; and hair in the shape of curling snakes. During the Classical period the fearsome aspects of the Medusa are gradually replaced by kinder and more feminine traits, and in the Hellenistic period the face becomes thoroughly pretty. No more glaring eyes or pro-



Fig. 68. Grave cippus, Kerameikos. Photo: Jenny Wallensten.

jecting tongue, but the hairstyle is still wild with free-flowing hair rather than the controlled coiffures favoured at the time. Lacking other attributes, the wild hair serves to identify the head as that of Medusa. The snakes still appear from time to time, but are then highly stylized as in the wreath around the head on the mirror in Geneva (Fig. 70).

It is not very easy to find close stylistic parallels, but the same chubby anatomy and flowing hair appear on an antefix from Taras, dated in the late fourth or early third century B.C.¹⁹⁴

As for the interpretation of the mirror as part of the grave goods, it is often

¹⁹² Schwarzmaier, 261 no. 65, pl. 60.1.

¹⁹³ Schwarzmaier, 336 no. 249, pl. 77.2.

¹⁹⁴ Taranto, M.A.N. inv. 17597, *Greci in Occidente*, 179 no. 129.

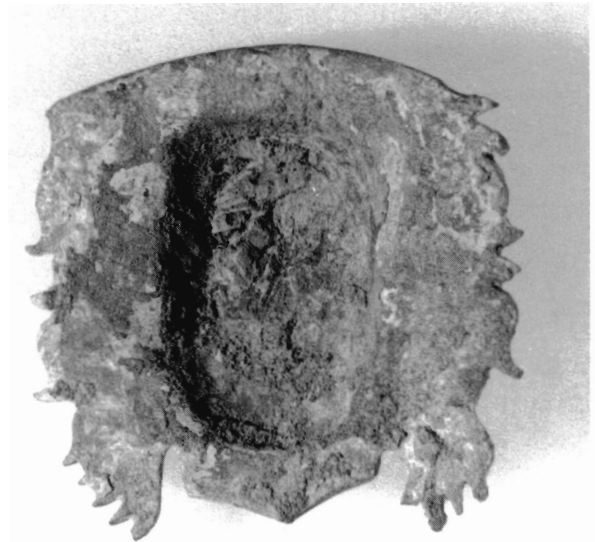

Fig. 69. Mirror no. 29: Medusa head, a) front, b) back. Photo: H. Frost.

Fig. 70. Mirror in Geneva.
Schwarzmaier no. 249, pl. 77.2.



taken for granted that it is, as it were, a reflexion of femininity. That is, how-

ever, a misconception, and for several reasons. Firstly, as already pointed out by Kurtz and Boardman in 1971, “we cannot always decide whether the ‘possessions’ are of the dead or gifts from the living, and so not always appropriate to sex”.¹⁹⁵ Secondly, “mirrors need not be unmasculine”: male vanity was not absent in Antiquity any more than at any other time, and there is nothing to say that men had lesser need of a looking glass than women did. Indeed, mirrors are often found with male burials,¹⁹⁶ and the mirror on the tombstone referred to above is indeed accompanied by an inscription to a man.¹⁹⁷ Similarly, even if they had a specific feminine connota-

¹⁹⁵ Kurtz and Boardman, 209.

¹⁹⁶ Houby-Nielsen, *Grave Gifts*, 221-22.

¹⁹⁷ Kerameikos, Iera Odos, *IG II/III*² 3,2, p. 530 no. 7598: ΔΗΜΑΡΧΟΣ ΦΙΛΩΝΟΣ ΦΑΛΗΡΕΥΣ, after the middle of the 3rd cent. B.C. The mirror hangs from a nail on the right.

tion in earlier periods, what had been taken as gender-specific grave goods such as strigils and mirrors appear to be more and more interchangeable from the end of the fourth century, coupled with “a striking lack of sex differentiation on Attic Hellenistic tombstones”.¹⁹⁸

Thus, the mirror in our grave does not as such give any clue as to the sex of the defunct. It was found in level I near the kantharos (no. 1), the filter jug (no. 5), and the figurine of the seated woman (no. 22), and beneath the jaw-bone of skeleton C (Fig. 8). One should therefore be able to conclude that it did not belong to the last burial.

Small bronze rings

30. F99-5043, 5052, 5053, 5054, 5059, 5060, 5061, 5065. GR3/3. Small bronze rings presumably used as eye-holes for shoes or other garment. Seven closed rings, two open, and two fragmentary. D. 0.9; Thickness 0.1-0.2.

A number of small bronze rings were found dispersed in the grave, but concentrated in the north-west corner (Figs. 71, 79). The most likely interpretation is that they were eye-holes for shoes.

Bronze sheet

31. F99-5044. GR 3/3. Rolled sheet of bronze. Length 1.7; Thickness 0.1-0.3.

The fragment of bronze sheet is not large enough to make an identification of the object to which it belonged pos-

sible. Several other bronze fragments were found in the grave, one between the legs of the last burial.

Other objects

Shells

Two shells were found in the grave: one loose and another in one of the echinus bowls (no. 12, Fig. 38).

Sanne Houby-Nielsen has demonstrated the connexion in grave assemblages, beginning in the late fourth century B.C., between shells and “strigils, mirrors and other toilet equipment”.¹⁹⁹ Shells are well attested in Hellenistic funerary contexts and were not deposited by accident: a grave in Patrae, from the second century B.C. and consequently later, as well as richer, than ours, contained two man-made silver shells.²⁰⁰

Fig. 71. Small bronze rings no. 30.
Photo: H. Frost.



¹⁹⁸ Houby-Nielsen, *Grave Gifts*, 243.

¹⁹⁹ Houby-Nielsen, *Grave Gifts*, 239.

²⁰⁰ Π.Α. Παπαποστόλου, *AD* 32 (1977), A', 326-27 no. 17, pl. 113γ-δ.

Fig. 72. Lid?, no. 34.
Drawing: A. Hooton.

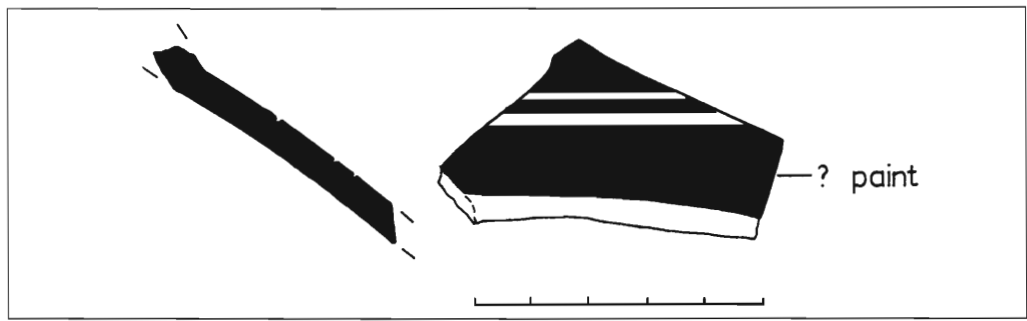
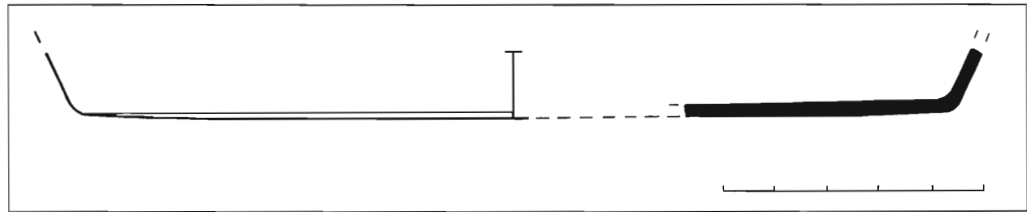

Fig. 73. Lopas no. 35.
Drawing: A. Hooton.



Like the dove figurines, the shells can be interpreted as a symbol of the goddess Aphrodite, who from the Early Hellenistic period makes her appearance as a terracotta figurine in an open mussel. The introduction of the figurines coincides with a change in the perception of the goddess, who in Hellenistic times became an “embodiment of beauty and marital love”.²⁰¹

32. F99-5009. GR3/3. Shell.

33. With F99-5041, no. 12. GR3/3. Shell.

Stray sherds

Apart from the vessels described above, thirteen lots of stray sherds were found in the grave, most probably part of accidental fill and not given specific find numbers. They are for the most part not

diagnostic, but the datable sherds are Hellenistic and a few possibly earlier. Two sherds were registered with find numbers and are described below (Figs. 72-73); the remainder are only identified by bag numbers.²⁰² One sherd had preserved West-slope decoration. A few fragments of roof tile had also ended up in the fill of the grave.²⁰³

34. F99-5029. GR3/3. Lid? Body sherd near top. H 4.6; W 6.0. Fine, soft brownish pink fabric (5YR 6/6) with small dark inclusions. Thin brown slip inside. Painted banded decoration out. Shallow grooves outside marking bands. Surface poorly preserved. Bichrome: brown and red or brown and white? Archaic?

35. F99-5030. GR3/3. Lopas. Base sherd. H 1.4; W 5.4; Thickness 0.2-0.3. Reddish buff cooking pot ware (7.5YR 7/6), sandy with abundant white, red and grey inclusions. Powdery surface. Sharp carination between floor and wall. Burning marks on underside.

²⁰¹ Houby-Nielsen, *Grave Gifts*, 244.

²⁰² Which means that they were collected from the buckets: the stratum to which they belong is known, but not their exact find spot.

²⁰³ F99-5007 and F99-5031.

Kantharos with knot handle

36. F99-5038. K26 GR3/3. Kantharos. Handle and part of wall. H 4.3; W 3.4; Thickness 0.2-0.3. Fine, very soft, pale brown (10YR 6/4) fabric. Pale surface. Traces of red slip inside and out. Double rolled handle formed into Herakles knot. Straight wall profile.

Since the sherd in question is only a small fragment (Fig. 74), and poorly fired at that, it is an open question whether it belonged to a kantharos deposited in the grave with one of the early burials, or it entered with the general soil fill. Found in level III (Fig. 10), it was rather deep among the finds in the north-west corner at the grave, and must have entered the grave at a rather early stage, at least before the final burial.

Owing to the small fragment preserved, we can only comment on the shape in general terms. The Herakles-knot handle, made from a double rolled handle tied into a knot, has its name from a passage in Athenaeus:

«... εἰργάσαντο κεραμέους τε καὶ ἀργυροῦς σκύφους. ὧν πρῶτοι μὲν ἐγένοντο καὶ κλέος ἔλαβον οἱ Βοιωτοὶ λεγόμενοι, χρησαμένου κατὰ τὰς στρατείας πρώτου Ἡρακλέους τῷ γένει· διὸ καὶ Ἡρακλεωτικοὶ πρὸς τινω καλοῦνται. ἔχουσι μέντοι πρὸς

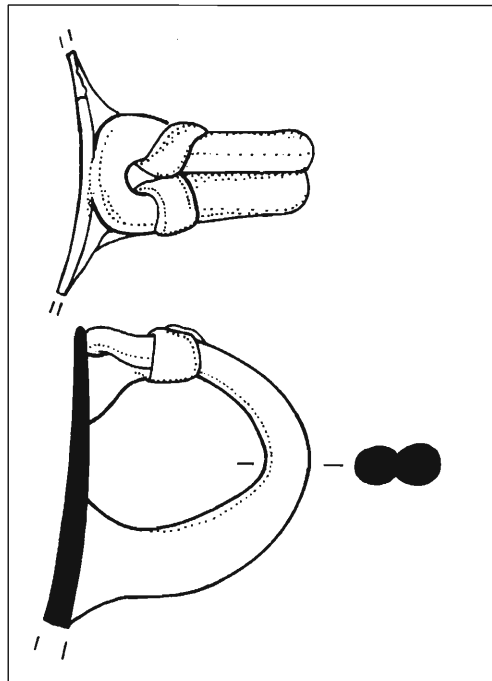

Fig. 74. Kantharos no. 36. Drawing: A. Hooton.

τοὺς ἄλλους διαφορὰν ἔπεστι γὰρ ἐπὶ τῶν ὄτων αὐτοῖς ὁ λεγόμενος Ἡρακλειος δεσμός.»²⁰⁴

The connexion with the name of Herakles is apparently the large size of the cups favoured by the god – his name is associated with anything outsized. In the archaeological evidence, and leaving Athenaeus apart, the knot appears on normal-size mugs in the fifth century,²⁰⁵ and was used on Late Classical Attic kantharoi as a device to vary the appearance of the handles.²⁰⁶ Apparently a sign of good luck, it also appears in jewellery in the fourth century.²⁰⁷ It

²⁰⁴ “... they manufactured skyphoi of clay and of silver. Of these the first to be made and to acquire repute were the so-called Boeotian skyphoi, and Heracles while on his campaigns was the first to make use of the style; hence they are also called ‘Heracleotic bowls’ by some. Nevertheless when compared with other skyphoi they show a difference; for upon their handles there is the so-called Heracleian chain.” (Athenaeus XI, 500a; trans. C. Burton Gulick).

²⁰⁵ *Agora* XII, 73 n. 22.

²⁰⁶ *Agora* XII, 123, 287 nos. 715-18, Fig. 7, pl. 29; *Agora* XXIX, 89-90 nos. 94-100, 251-52, fig. 9, pl. 10.

²⁰⁷ *Agora* XXIX, 89 n. 21.

survives into the early third century on the Classical kantharos types but does not occur, in Attica, on the new Hellenistic models introduced early in that century.

At Corinth, however, it is found on kantharoi of the 'one-piece' (more common with rectangular thumb-rests, like those on three of the complete kantharoi from the grave) and 'Acrocorinth' types.²⁰⁸ It also features on a kantharos with angular profile on a pedestal base from Isthmia.²⁰⁹

A 'one-piece kantharos' with rounded profile on a conical ring foot, and with a West-slope garland in the handle zone, comes from a cemetery at Patrae across the Calydonian Gulf. It is dated, by stylistic comparisons, in the first half of the third century.²¹⁰

Loom weight

37. F99-5002. GR3/1. Pyramidal loom weight. Top missing. H 5; base 4 x 4 cm. Coarse fabric: pink core (5YR 6/4), yellowish pink surface (5YR 7/6), soft, white and brown inclusions and large voids.

Apart from the stray sherds, a pyramidal loom weight (Fig. 75) should also be characterized as a stray find, since it was found in an upper level of the grave and probably did not form part of the grave goods.

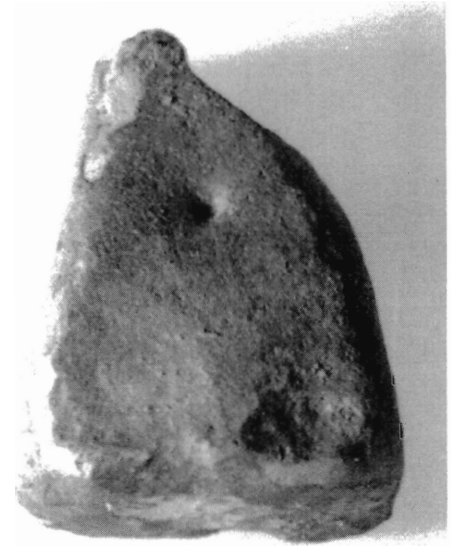

Fig. 75. Loom weight no. 37.
Photo: H. Frost.

Tile

There were approximately 175 fragments of tile found in the grave in all levels. Most were found in the upper levels, above the burials. Only ten fragments were found in the burial levels, and two beneath the burials, in the stone packing. The diagnostic tile fragments were of Hellenistic date, a fact which strengthens the suspicions that the grave had already been filled in the Hellenistic period. One tile fragment (F99-5031) had been placed under the skull of the last burial.

²⁰⁸ *Corinth* VII,3, 74-76 nos. 380, 386-87, pls. 15, 52; *op.cit.* 82-83 nos. 451-57, pls. 15, 53.

²⁰⁹ V.R. Anderson-Stojanović, *Δ'ΕλλΚεQ*, 15, pl. 5, no. IP 688.

²¹⁰ Δ. Κυριακού, *Γ'ΕλλΚεQ*, 190, pl. 134 no. 5043..

Fig. 76. GR3: jugs – kantharoi
Drawing: A. Hooton.

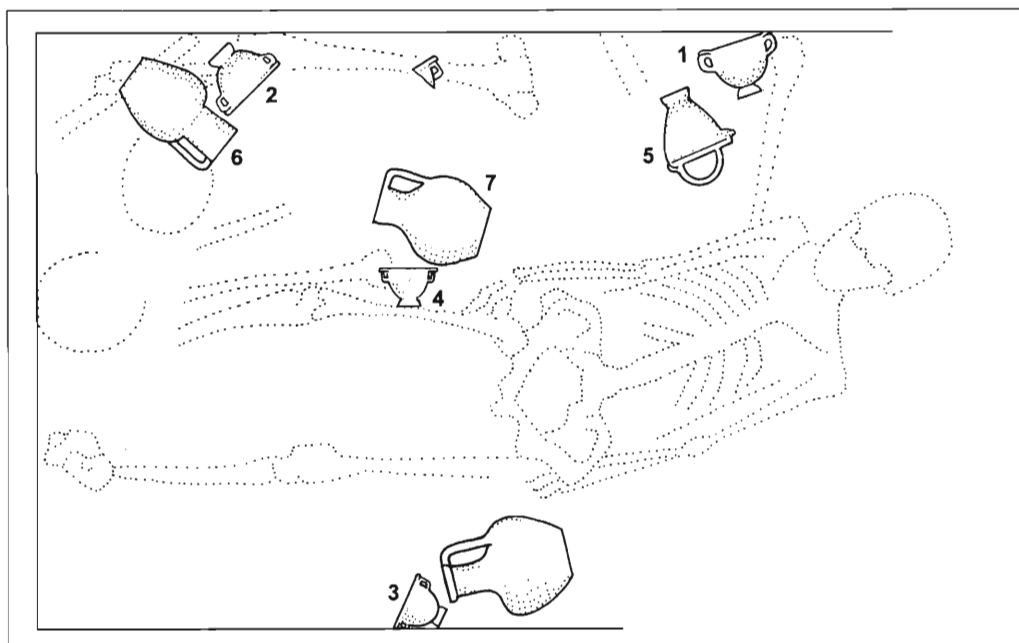

Conclusions

As we have seen, the grave goods found in this multiple-burial grave can be quite neatly divided among the four skeletons by numbers: there were four food-bowls, four drinking cups, four jugs, four lamps, and four human terracotta figurines, two of which were found complete. But there the equation stops: in the grave were also two dove figurines, and among singletons were an unguentarium, a pyxis and a miniature krater. Other objects, which did not form part of the repeated assemblage, include a gold ring, gold beads, a mirror and a silver coin.

The last burial was a woman, found *in situ*. She was over 40 years old when she died and had suffered arthritis and caries (see appendix). Her head rested on a fragment of roof tile, and she had been given a coin in her mouth to pay the passage of Charon (no. 28). Moreover, she had been wearing a necklace: a gold-leaf coated bead (no. 27) was

found near her right shoulder and other beads were found dispersed in the earth fill. A fragment of an unidentified bronze object was found between her legs.

Among the vases accorded to her are the kantharos, no. 3, and the jug, no. 8, both placed next to her left thigh, i.e. on the other side of the body with respect to the grave goods, which had been deposited with the earlier burials and swept into the northwest corner (Fig. 76). Although it would be tempting to accord to her a bowl for eating as well as a lamp, since the number of objects in each of those categories present in the grave corresponds to the number of burials, there is neither a specific bowl nor a lamp, which by its find location can be associated with the last burial. That archaeological problem is made evident in Fig. 77: the bowls (nos. 9-12) were all found in close proximity to each other in the northwest corner of the grave, and the lamps were found in two pairs, one near the bowls (nos. 18

Fig. 77. GR3: bowls – lamps
Drawing: A. Hooton.

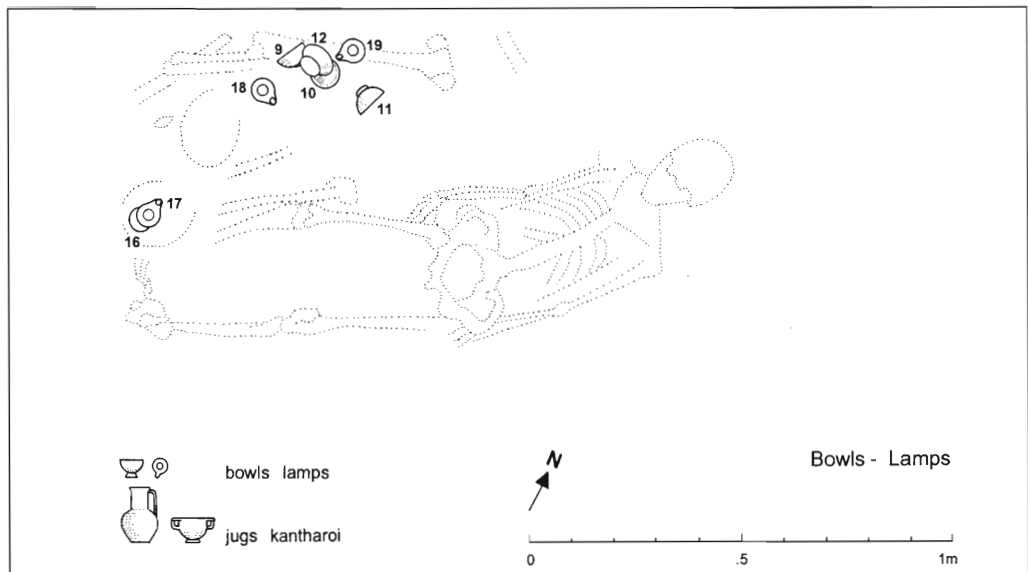
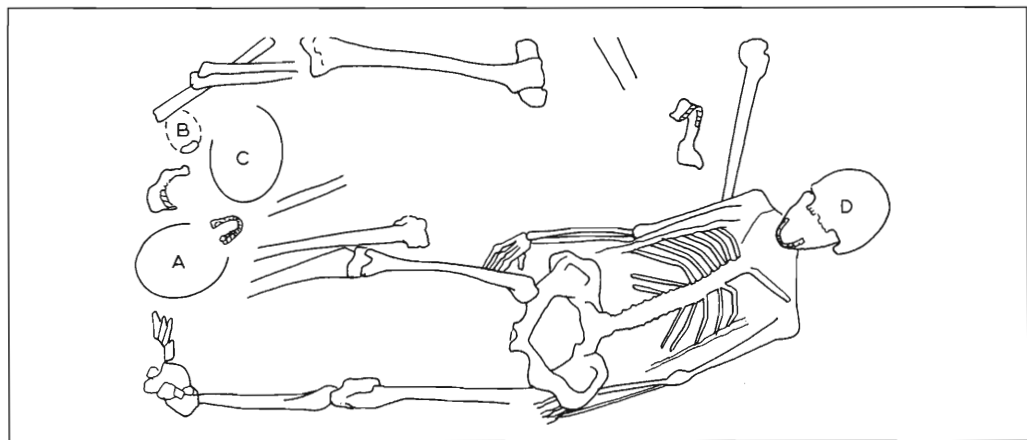

Fig. 78. GR3: skulls – bones
Drawing: A. Hooton.



and **19**), the other near the feet of the last burial (nos. **16** and **17**).

Further, the bowls and lamps were found at a lower level than the last burial, and the two lamps, nos. **16** and **17**, actually directly beneath the skull of skeleton **A** (Fig. 9). Hence they should be associated with the earlier burials, unless – and that is perhaps an important objection – a lamp and a bowl were used ceremonially during the deposition of the defunct and mixed with the earlier grave goods when these were swept into the corner. That is, on the face of it, less likely but we cannot be certain until we have a clearer idea of the burial customs in the area. Lamps are, as mentioned earlier,

common as grave goods and carry a symbolic value. Why would the lamp be omitted in the last burial, when it was an important feature of the earlier three, as well as in other contemporary burials in the region?

The earlier burials were a woman of 25 to 28 years of age (**A**), a child of undeterminable sex, two to four years old (**B**), and a man with an estimated age of 30 to 35 years (**C**). The skulls and bones were piled up in the northwest corner of the grave (Fig. 78), and it is neither possible to say in which order they had been buried, nor to associate the finds with the individuals. The excavator, Sanne Houbj-Nielsen, ob-

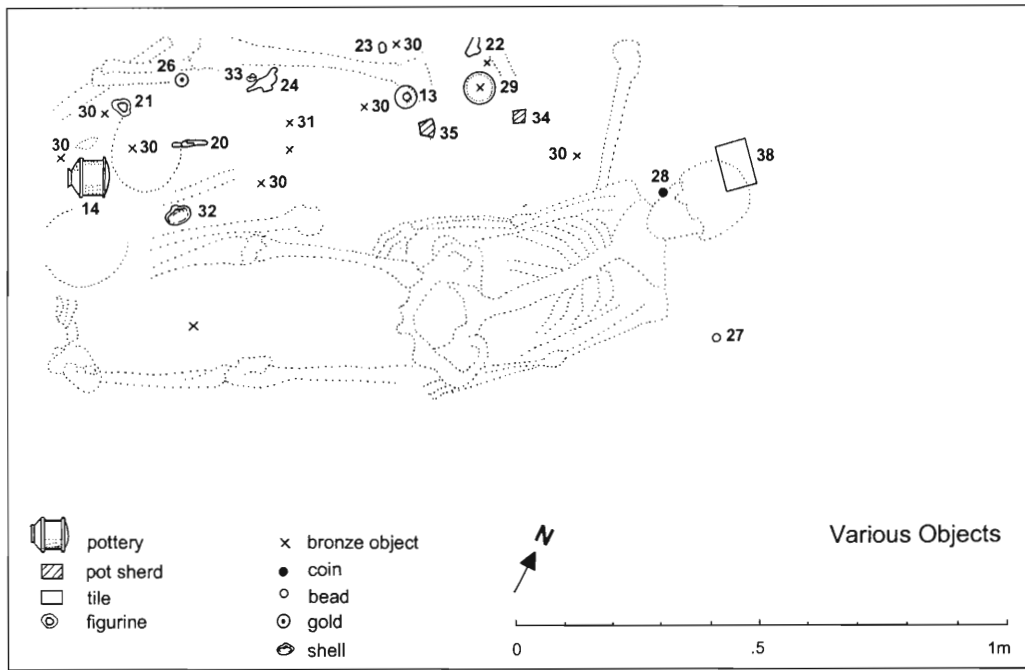

Fig. 79. GR3: various objects.
Drawing: A. Hooton.

served however that the grave-goods in the corner had been placed there with some care: “Thus, all vases found among the bones of the three earlier burials were unbroken, and several still had their contents preserved intact, indicating that the vases were moved carefully. For instance, a kantharos still held bird (?) bones and a miniature dove, another kantharos still held as-tragals and one saucer still held a seashell. The presence of a bronze mirror and gold ring also proves that the persons in charge of the last burial resisted the – otherwise likely – temptation to remove valuable objects.”

She also noticed how the figurine of the girl with toys (no. 20) was left leaning against the skull of the deceased man (C) and that other objects were grouped around the skulls, as if displaying the ownership of the objects. The care taken

over the grave goods perhaps indicates that it was a family tomb. DNA analysis of the bones have unfortunately not yielded any useful results so that conclusion will have to remain a conjecture.

As revealed by Fig. 76, the jugs and drinking cups were deposited by pairs in the grave. Those vessels have stayed in pairs even in the case of the three earlier burials, while most other goods formed part of the great pile of objects and bones. The pair of jug and cup is a general feature in other graves in the region, but the question remains how much eating bowls and lamps formed part of the standard equipment. In the publication of the grave at Trichonio, only the pouring vessel (situla-kados), drinking cup (kantharos), and lamp are listed and no mention is made of a bowl or a plate.²¹¹ In grave GR2 at Chalkis, on the other hand, there were two eat-

²¹¹ *Trichonio*, 324, pl. 163.

ing-vessels present, a small echinus bowl and a plate.²¹² Other items are extra and varying from case to case: pyxides, figurines, jewellery. Rarely, we also find metal vessels replacing the ceramic ones.²¹³

A vessel in which to mix the strong wine with water lacks in this assemblage, as in so many other graves of the period. The drinking of undiluted wine is a rare occurrence throughout Antiquity and regarded, both in Greece and Rome, as uncivilized behaviour.²¹⁴ The lacking krater is proof that whoever deposited the pottery assemblage in the grave was under no illusion that it would *actually* be used but rather saw it as a *representation* of a meal. For had the vessels been put in the

grave with an eye of practical use, the wine-service – jug and cup – would also have been accompanied by a mixing bowl.

As already stated, a further analysis of the grave goods will be deferred until a general review of the burial customs in Western Greece can be carried out, but one further remark should be made. If the interpretation of four sets of service for four burials is correct, we must accept that the child was given the same ‘adult’ treatment as the others. Objects naturally be connected with a child’s burial would be the figurine of a girl with toys (no. **21**), and, as mentioned above, the miniature krater (no. **15**), but there is no evidence that those had been deposited with the dead child.

²¹² I. Moschos in *SPR*, 297 no. Gr2.2, Figs. 66, 72; 298 no. Gr2.4, Figs. 68, 72.

²¹³ See *e.g.* graves, contemporary with ours, with gold and silver vessels at Trichonio: *Trichonio*, 324-26, pls. 164-65.

²¹⁴ *E.g.* Athenaeus 10.426-27, quoting older sources; cf. *Amm. Marc.* 15,12 (on what Cicero said of the Gauls).

The Human Remains

by Marie Louise S. Jørkov

In the summer of 2001 a basic anthropological examination was conducted on the human remains found in the Hellenistic grave in trench K26 during the season of 1999. The main purpose was to establish the number of individuals buried, assess their sex and estimate their age at death. Pathological alterations and degenerative signs were described in order to form an idea of their general health status. There is no other recorded skeletal material from Hagia Triada.

The state of the bones was fragmentary. The soil conditions near sea level – very moist, with much clay and sand – had caused the remains to be highly friable and subject to rapid fragmentation when exposed and handled. No preservative to stabilise the bones had been added at the time of excavation.

Morphological methods were used to estimate the age: by looking at pelvic features the auricular surfaces (surface on the pelvis that articulates with sacrum),²¹⁵ and, when present, the pubic symphysis.²¹⁶ Dental wear²¹⁷ and tooth eruption²¹⁸ were also examined. They all exhibit systematic age-related

changes. The pubic symphysis and the auricular surface are considered to be among the most reliable criteria for estimating age-at-death of adults, while the formation of tooth eruption is the most accurate criterion when dealing with juvenile remains. Because there is a considerable variability in closure rates of the cranial sutures they are only useful when other criteria are not available. It was therefore not considered important in any of the cases studied.

A scoring system of sexually dimorphic cranial,²¹⁹ as well as pelvic,²²⁰ features was used to assess the sex of the defunct. Among cranial criteria were the mastoid process (small in female, large in male), supra-orbital margin (sharp in female, rounded in males), supra-orbital ridge (smooth in female, round projection in male), nuchal crest (smooth in female, projecting in male) and the mental eminence of the mandibular (no or little projecting eminence in female, square pronounced eminence in male). They were given a score 1-5, where 1 = female, 2 = possible female, 3 = ambiguous sex, 4 = possible male, 5 = male. The pelvic feature was the greater sciatic notch of the ilium, which tends to be broad in females and narrow in males, and the subpubic angle, also broad in females and narrow in males.

²¹⁵ R.S. Meindel and C.O. Lovejoy, in M.Y. Iscan (ed.), *Age Markers in Human Skeletons* (Springfield, Ill. 1989), 137-68.

²¹⁶ T. McKern and T.D. Stewart, *Skeletal Age Changes in Young American Males, Analysed from the Standpoint of Identification*, Technical report EP-45, Headquarters, Quartermaster Research and Development Command (Natick, Mass. 1957), 85.

²¹⁷ D.R. Brothwell, *Digging up Bones*, 3rd ed. (New York 1981), 72.

²¹⁸ Ubelaker, 64.

²¹⁹ G. Acsádi and J. Nemeskéri, *History of Human Life Span and Mortality* (Budapest 1970).

²²⁰ J.E. Buikstra and D.H. Ubelaker (eds.), *Standards for Data collection from Human Skeletal Remains* (Fayetteville, Ark. 1994), 16-18.

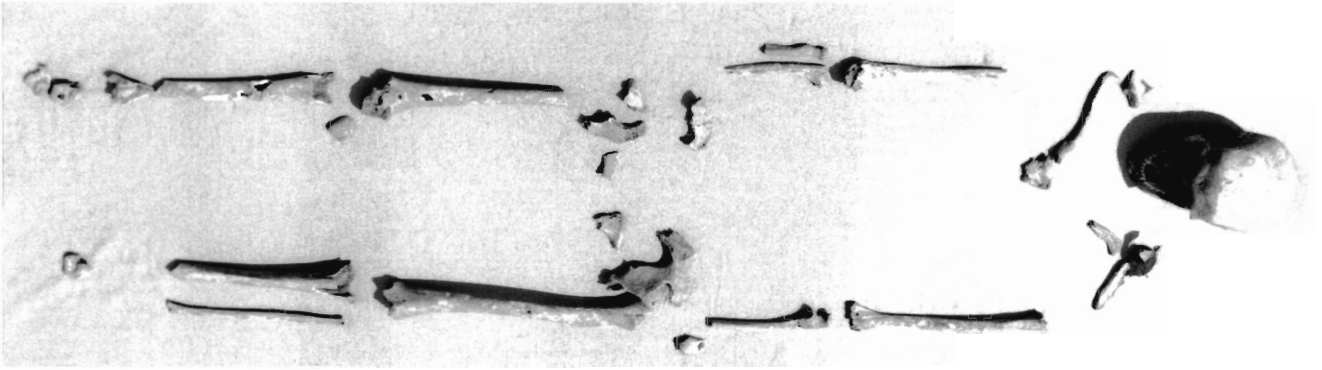

Fig. 80. Skeleton A: young adult female, from the earlier burials.
Photo: H. Frost.

Secondary burials

Secondary burials had been swept aside in the western corner allowing the grave to be reused. These remains could be sorted into three individuals by anatomical grouping and size. Two were adults and one a child.

Skeleton A

Skeleton A (F99-5017; fig. 80) was 50% complete with maxilla missing, no long bones intact, no identified ribs or vertebrae. In spite of the fragmentary state of the ossa coxae, the left ilium with au-

ricular surface and the left pubic symphysis were present. The teeth showed only slight occlusal wear. The age was estimated at 25 to 28 years at the time of death. The cranial features as well as the light bone structure indicated a female.

Of pathological alterations slight calculus (calcified plaque) on the molars of the mandibular and enamel hypoplasia on the incisors of the mandibular could be observed. Enamel hypoplasia is seen as horizontal lines in the enamel.²²¹

The frontal bone had an unfused metopic suture (Fig. 81), which usually ossifies at the age of two, but it is not an unfamiliar trace. It was in this case not possible to estimate the height, since there was not any complete long bones to measure.

Skeleton B

The smallest skeleton of the burials (F99-5048; Fig. 82) belonged to a child. The remains were scanty. However, a fragment of the mandible with a deciduous molar and incisors and a crown of an undeveloped permanent M1 could

Fig. 81. Skeleton A: metopic suture.
Photo: H. Frost.



²²¹ Mays, 156-61.

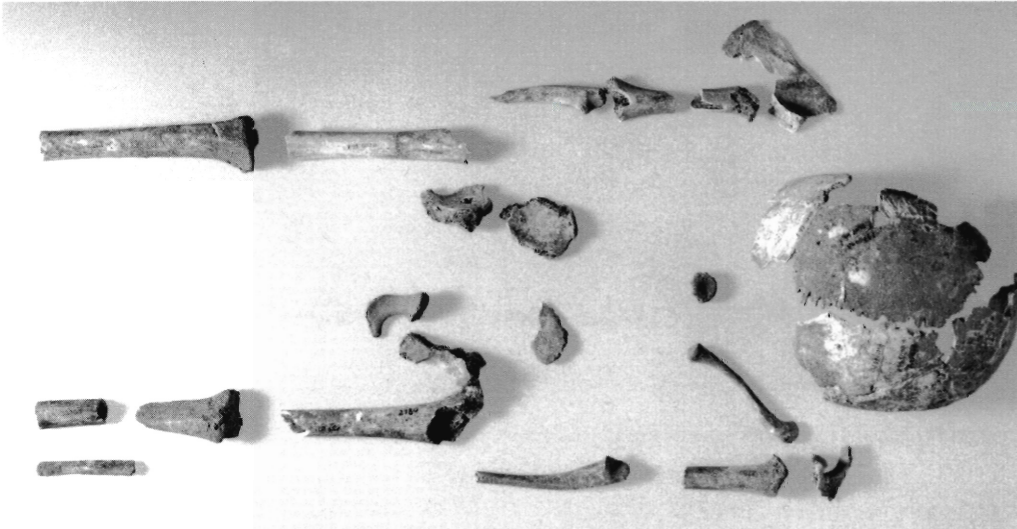

Fig. 82. Skeleton B: young child.
Photo: H. Frost.

be identified. The long bones had not yet ossified with the epiphysial plates. From the teeth, using the sequence of formation and eruption scheme by Ubelaker,²²² an estimated age of 3 years +/- 12 months was given.

The sex was not determined. The parietal bones and the occipital bone showed porosity along the lambdoid suture (Fig. 83).

Skeleton C

Skeleton C (F99-5018; Fig. 84) was 75% complete, with the left part of maxilla, left humerus, sacrum, tarsals and carpals missing. The ribs and vertebral column was too fragmentary to be identified. The age was estimated to be between 30 and 35 years at the time of death.

The cranium showed distinctive male features and the remaining postcranial elements were likewise robust.



Fig. 83. Skeleton B:
porotic hyperostosis on the
temporal and occipital vault.
Photo: H. Frost.

The deceased had suffered from bilateral carious infection on the left M1 and M2 of the mandible and had an abscess around the M1 root, posterior-superior to the left mental foramen (Fig. 85). The teeth of the mandible also showed slight calculus.

²²² Ubelaker, 64.



Fig. 84. Skeleton C: the adult male of the secondary burials. Note the shortening of the left femur and the asymmetrical shortening of the femoral neck. The diaphysis of the right femur deviates slightly lateral/medial.
Photo: H. Frost.

The stature of this person was estimated to have been c. 175 centimetres with an error of 2.99 cm. The calculation was based on the length of left tibia (38.8 cm) and left femur (46.7 cm) using the method by Trotter and Gleser.²²³ However, it should be noted that the right femur was longer than the left femur even though it was fragmented. There was also a shortening of the left femoral neck. The right femur deviated slightly lateral/medial.

The primary burial: skeleton D

The primary burial (F99-5019) was placed on its back facing upwards, with arms down the sides of the body (Figs. 6, 86).

The skeleton was complete with exception of a missing maxilla and fragmented epiphysis of the major long bones. The vertebral column and ribs were in very fragmentary state, although a few of the cervical vertebrae were intact. The pubic symphysis was not present and could therefore not be taken into account when assessing the age. The dental wear was moderately heavy with frequent partial exposure of the dentine. The age was estimated at 40 to 45 years or older.

Fig. 85. Skeleton C: severe caries infection on the left first molar and an abscess around the molar root for puss drainage. Calculus seen on the buccal side of the left premolar crowns.
Photo: H. Frost.



Since the pubic bones of the pelvis were missing, it was not possible to use the subpubic angle to assess the sex of the skeleton. The shape of the greater sciatic notch on the illium of the pelvis and

²²³ M. Trotter and G.C. Gleser, *American Journal of Physical Anthropology* 16 (1958), 79-123.

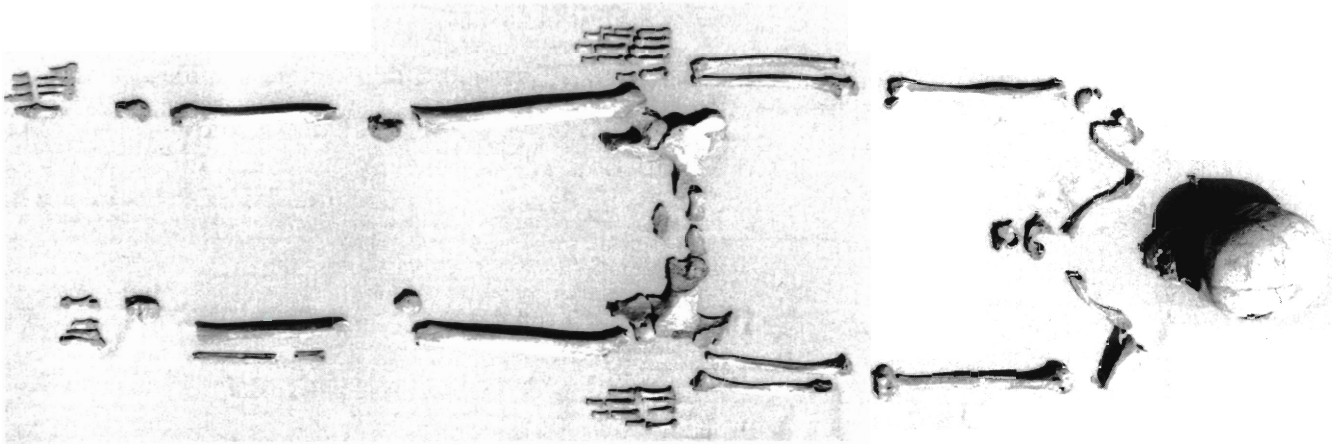

Fig. 86. Skeleton D: middle-aged adult female from the primary burial.
Photo: H. Frost.

the cranial features pointed towards a female.

Among pathologies this middle-aged adult showed arthritis on the cervical vertebrae (Fig. 87), and bony outgrowths (osteophytes) were seen on both acromial ends of the clavicles, and on the right first metacarpal. This could possibly be related to age or a result of trauma earlier in life. There was a caries infection in the molar teeth of the maxilla, and slight calculus on the mandibular teeth.

The stature was estimated to have been c. 153 centimetres, with an error margin of 4.33 cm, according to the correlation equations by Trotter and Gleser.²²⁴ The estimate is not likely to be very accurate since it is based on the length of the upper limbs (left humerus 28.1 cm, right radius 20.6 cm, right ulna 22.6 cm), which is not as strongly correlated with living stature as the bones of the leg.

Summary

This group of four individuals is only a very small sample of the population that lived at Chalkis in the Hellenistic period, and we cannot say much more about them than their age and sex.

The primary burial was of a middle-aged female of 40-45+ years at the time of death and of a height of c. 153 centimetres. She had suffered from age-related arthritis on her vertebral column. The osteophytes on her clavicles could be the cause of an infection due to trauma, or simply age-related change. She had serious tooth wear that exposed the

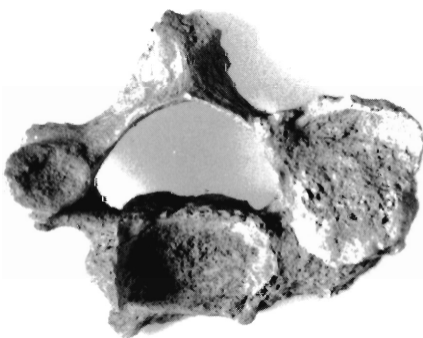
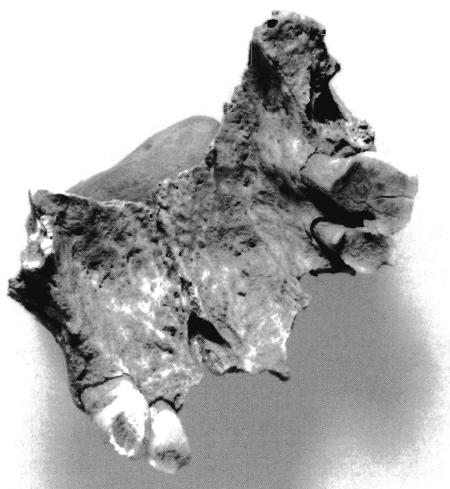

Fig. 87. Skeleton D: cervicle vertebra with joint contour change. Osteophytosis affecting the left superior and inferior articulating facet and vertebral body.
Photo: H. Frost.

²²⁴ *Ibidem*.

Fig. 88. Skeleton D: fragment of the maxilla. The teeth show severe tooth wear. A caries infection is seen on the right first molar on the mesial side. The second and third molars in both left and right side have been lost ante mortem, and bone remodelling of the alveolar cavities have taken place.

Photo: H. Frost.



dentine and had lost most of her molars, possibly due to caries infection (Fig. 88).

Skeleton A was an adult female in her twenties. During the natal phase she suffered malnutrition or other kind of systematic stress such as infectious disease, which had an effect on the mineralization of enamel during dental development. Enamel formation is cumulative, and provides a chronological and almost permanent record of non-specific stress episodes during the pre-natal and post-natal periods.²²⁵ This disturbance is seen as linear horizontal grooves on the enamel called enamel hypoplasia. In this case it was seen on the incisors. These indicated that the stress episode occurred between pre-natal and birth when the incisors developed.²²⁶

The skeletal remains of a young child, skeleton B, indicated an age of three years +/- 12 months at the time of death. The cranial vault showed porotic hy-

perostosis, which could be caused by dietary deficiency or iron deficiency (Fig. 83). Four decades ago, J.L. Angel found that a genetic anaemia he called *thalassemia* (a sickle cell anaemia) occurs in the Mediterranean and has been the cause of porotic hyperostosis and Cribra Orbitalia. The evidence in this case is however very limited. Another thing to note on the occipital vault of the cranium, just inferior to the lambdoid suture, is what looks like a healed sharp force injury to the back of the head. In this case it would be extremely interesting to know whether it was due to an accident or intended force to the skull. However, a conclusion will not be made before a more thorough examination of the cranium has been conducted.

The middle-aged male, skeleton C, was 30 to 35 years old and approximately 175 centimetres tall. He suffered from caries infections, which, at one point, was followed by a pulp chamber inflammation. The abscess, seen on the left buccal side of the mandibular, is a drainage channel for the puss from this inflammation (Fig. 85). Once the puss could escape, the pressure was released and the infection became chronic with no pain. Caries and calculus are particularly common among agricultural populations, whose diet includes soft-cooked produce and in this case also seafood. What was also interesting to note was the difference in the length of the femura. The left was much shorter and had an asymmetrical shortening of the femoral neck, which probably was congenital and not caused by trauma.

²²⁵ Mays, 156-61.

²²⁶ Ubelaker, 64.

This shortening of the left leg might have caused the person to limp. However, there is no evidence of a dominating side, and we must therefore conclude that this person was not affected or disabled by the shortening.

The dark round shadows on the cranial vault that can be seen on Fig. 84 might be taphonomic, caused by roots. If they were caused by disease, an x-ray of the skull would be needed to clarify the matter.

The cause of death in each of the four cases is not possible to determine. Nor is it possible to say whether the individuals of the earlier burials died and were buried at the same time or whether they died from various causes at intervals of perhaps decades. The size of the grave does not seem to allow more than one person at a time. The archaeological material buried with all four individuals indicates a narrow time span in

the Hellenistic period, which could lead to the question whether all four individuals are related.

Unfortunately most archaeologists have ignored the human skeletal remains when excavating burials. Anthropological analysis of the human remains is, however, very useful when reconstructing life of past populations. It provides us with important information about a population or a single individual that cannot be derived from the archaeological record alone. Each skeleton represents an individual, whose story can only be told by analysing the bones. It is not only the physical appearance of the bones that can give us information. Elemental analysis and stable isotope analysis are relatively new components in the investigation of past peoples' lives. They can be used when studying migration patterns, special and temporal variation in diet, status, sex, and age differences.

References

- AA*
Archäologischer Anzeiger
- ActaArch*
Acta Archaeologica
- AD*
Αρχαιολογικόν Δελτίον
- AE*
Αρχαιολογική Εφημερίς. Περιοδικόν της εν Αθήναις Αρχαιολογικής Εταιρείας
- Α'ΕλλΚερ*
Α' Συνάντηση για την ελληνιστική κεραμική. Δεκέμβρης 1986 (Ioannina 1989)
- Α'ΕλλΚερ²*
Α' Συνάντηση για την ελληνιστική κεραμική. Πρακτικά. Ιωάννινα, 6 Δεκεμβρίου 1986. Πανεπιστήμιο Ιωαννίνων – Τομέας Αρχαιολογίας. 2^η Έκδοση (Rhodes 2000)
- Agora IV*
R.H. Howland, *Greek Lamps and Their Survivals. The Athenian Agora: Results of Excavations Conducted by the American School of Classical Studies IV* (1958)
- Agora XII*
B.A. Sparkes and L. Talcott, *Black and Plain Pottery of the 6th, 5th and 4th Centuries BC. The Athenian Agora: Results of Excavations Conducted by the*
- American School of Classical Studies XII* (1970)
- Agora XXI*
M. Lang, *Graffiti and Dipinti. The Athenian Agora: Results of Excavations Conducted by the American School of Classical Studies XXI* (1976)
- Agora XXIX*
S.I. Rotroff, *Hellenistic Pottery: Athenian and Imported Wheel-made Table Ware and Related Material. The Athenian Agora: Results of Excavations Conducted by the American School of Classical Studies XXIX* (1997)
- AJA*
American Journal of Archaeology
- AM*
Mitteilungen des Deutschen Archäologischen Instituts, Athenische Abteilung
- Babesch*
Bulletin Antieke Beschaving
- BCH*
Bulletin de Correspondance Hellénique
- BICS*
Bulletin of the Institute of Classical Studies
- Blondé, *Thorikos*
F. Blondé, *Greek Lamps from Thorikos [=Miscellanea Graeca 6]* (Ghent 1983)
- BM Lamps I*
Bailey, D.M., *A Catalogue of the Lamps in the British Museum I, Greek, Hellenistic, and Early Roman Pottery Lamps* (London 1975)
- BM Terracottas III*
L. Burn and R. Higgins, *Catalogue of Greek Terracottas in the British Museum III* (London 2001)
- BSA*
Annual of the British School at Athens
- Bürgerwelten*
I. Kriseleit and G. Zimmer (eds.), *Bürgerwelten. Hellenistische Tonfiguren und Nachschöpfungen im 19. Jh., Staatliche Museen zu Berlin, Preußischer Kulturbesitz, Antikensammlung 29.1-30.4 1994* (Mainz a.R. 1994)
- Corinth IV,2*
O. Broneer, *Terracotta Lamps. Corinth: Results of Excavations Conducted by the American School of Classical Studies IV, part II* (1930)
- Corinth VII,3*
G.R. Edwards, *Corinthian Hellenistic Pottery. Corinth: Results of Excavations Conducted by the American School of Classical Studies VII, part III* (1975)
- Corinth XVIII,1*
E.G. Pemberton, *The Sanctuary of Demeter and Kore. The*

- Greek Pottery. Corinth: Results of Excavations Conducted by the American School of Classical Studies XVIII, part I* (1989)
- Coroplast's Art*
J.P. Uhlenbrock, et al., *The Coroplast's Art. Greek Terracottas of the Hellenistic World*, Princeton, New York, Cambridge (Mass.), 1990-91 (New York 1990)
- Δ'ΕλλΚερ
Δ'Επιστημονική συνάντηση για την ελληνιστική κεραμική: Χρονολογικά προβλήματα. Κλειστά σύνολα - εργαστήρια (Athens 1997)
- Derveni*
Π.Γ. Θέμελης and Γ.Π. Τουράτσογλου, *Οι τάφοι του Δερβενίου* (Athens 1997)
- DNP*
H. Cancik and H. Schneider (eds.), *Der neue Pauly. Enzyklopädie der Antike* (Stuttgart and Weimar 1996-)
- Ε'ΕλλΚερ
Ε'Επιστημονική συνάντηση για την ελληνιστική κεραμική: Χρονολογικά προβλήματα. Κλειστά σύνολα - εργαστήρια. (Athens 2000)
- Eretria X*
K. Reber et al., *Die klassischen und hellenistischen Wohnhäuser im Westquartier. Eretria: Ausgrabungen und Forschungen X* (1998)
- Γ'ΕλλΚερ
Γ'Επιστημονική συνάντηση για την ελληνιστική κεραμική: Χρονολογημένα σύνολα - εργαστήρια. 24-27 Σεπτεμβρίου 1991, Θεσσαλονίκη (Athens 1994)
- Graepler*
D. Graepler, *Tonfiguren im Grab. Fundkontexte hellenistischer Terrakotten aus der Nekropole von Tarent* (Munich 1997)
- Greci in Occidente*
E. Lippolis (ed.), *I greci in Occidente. Arte e artigianato in Magna Grecia* (Naples 1996)
- Higgins, Tanagra*
R. Higgins, *Tanagra and the Figurines* (London 1987)
- Houby-Nielsen, Grave Gifts*
Houby-Nielsen, S., 'Grave Gifts, Women, and Conventional Values in Hellenistic Athens', in P. Bilde et al. (eds.), *Conventional Values of the Hellenistic Greeks* (Aarhus 1997), 220-62
- HPT*
H.A. Thompson, D.B. Thompson and S.I. Rotroff, *Hellenistic Pottery and Terracottas* (Princeton 1987)
- Isthmia III*
O. Broneer, *Terracotta Lamps. Isthmia: Excavations by the University of Chicago under the Auspices of the American School of Classical Studies at Athens III* (1977)
- JHS*
Journal of Hellenic Studies
- Kabirion III*
U. Heimberg, *Die Keramik des Kabirions. Das Kabirenheiligtum bei Theben III* (Berlin 1982)
- Kabirion IV*
K. Braun and T.E. Haevernick, *Bemalte Keramik und Glas aus dem Kabirenheiligtum bei Theben. Das Kabirenheiligtum bei Theben IV* (Berlin 1981)
- Kerameikos IX*
U. Knigge, *Kerameikos: Ergebnisse der Ausgrabungen IX, Der Südhügel* (1976)
- Kerameikos XI*
I. Scheibler, *Kerameikos: Ergebnisse der Ausgrabungen XI, Griechische Lampen* (1976)
- Knossos KPH*
J.N. Coldstream and L.J. Eiring (eds.), *Knossos Pottery Handbook: Greek and Roman. BSA Studies 7* (2001)
- Kotitsa*
Kotitsa, Z., *Hellenistische Tonpyxiden: Untersuchung zweier hellenistischer Typen einer Keramikform* (Mainz am Rhein 1996)
- Kurtz and Boardman*
D.C. Kurtz and J. Boardman, *Greek Burial Customs* (London 1971)

- Labraunda* II:1
P. Hellström, *Pottery of Classical and Later Date. Terracotta Lamps and Glass, Labraunda. Swedish Excavations and Researches* II:1 = *Skrifter utgivna av svenska institutet i Athen*, 4°, V, II:1 (Lund 1965)
- LS*
H.G. Liddel and R. Scott, *A Greek-English Lexicon*, 9th ed. (1940, repr. 1989)
- Macedonia*
Σ. Δρούγου (ed.), *Ελληνιστική κεραμική από τη Μακεδονία* (Thessalonica 1991)
- Mays*
S. Mays, *The Archaeology of Human Bones* (London 1998)
- Metaponto*
J.C. Carter, *The Chora of Metaponto: The Necropoleis*, I-II (Austin, Texas 1998)
- MNC³ I-II*
T.B.L. Webster, *Monuments Illustrating New Comedy*, Third edition revised and enlarged by J.R. Green and A. Seeberg, I-II, *BICS* Suppl. 50 (1995)
- ÖJh*
Jahreshefte des Österreichischen archäologischen Institutes in Wien
- OF XXIII*
J. Schilbach, *Elische Keramik des 5. und 4. Jahrhunderts.*
- Olympische Forschungen XXIII* (1995)
- OlBericht* III
E. Kunze and H. Schleif, *III. Bericht über die Ausgrabungen in Olympia, Winter 1938/39* (1939)
- PDIA*
Proceedings of the Danish Institute at Athens
- RE*
Paulys Realencyclopädie der classischen Altertums-wissenschaft (Stuttgart 1901-)
- Schwartzmaier
A. Schwartzmaier, *Griechische Klappspiegel. Untersuchungen zu Typologie und Stil*, *AM* 18. Beiheft (Berlin 1997)
- SPR*
S. Dietz, L. Kolonas, S. Houbby-Nielsen and I. Moschos (eds.), 'The Greek Danish Excavations in Aetolian Chalkis 1997-1998. Second Preliminary Report', *PDIA* III (2000), 219-307
- Tanagra und Ephesos*
Griechische Terracotten aus Tanagra und Ephesos im Berliner Museum (Berlin 1878)
- Taranto* II,1
A. Dell'Aglio and E. Lippolis, *Catalogo del Museo Nazionale Archeologico di Taranto* II,1, *Ginosa e La-terza. La documentazione archeologica dal VII al III sec. a.C. Scavi 1900-1980* (Taranto 1995)
- Taranto* III,1
E. Lippolis (ed.), *Catalogo del Museo Nazionale Archeologico di Taranto* III,1, *Taranto. La necropoli: aspetti e problemi della documentazione archeologica tra VII e I sec. a.C.* (Taranto 1994)
- Tel Anafa* II,i
S.C. Herbert (ed.), *Tel Anafa* II,i, *The Hellenistic and Roman Pottery, Journal of Roman Archaeology* Suppl. 10, part II,i, (1997)
- TPR*
S. Dietz, L. Kolonas, S. Houbby-Nielsen, I. Moschos and J. Eirring, 'Greek-Danish Excavations at Aetolian Chalkis 1999-2001. Third Preliminary Report', in *PDIA* IV (2002), 167-259
- Trichonio*
Φ.Ν. Ζαφειροπούλου, «Τάφοι στο Τριχόνιο Αιτωλίας», in *Ε'ΕλλΚερ*, 323-28
- Ubelaker
D.H. Ubelaker, *Human Skeletal Remains. Excavation, Analysis, Interpretation*, 3rd ed. (Washington D.C. 1999)
- Vokotopoulou, *Guide*
J. Vokotopoulou, *Guide to the Archaeological Museum of Thessalonike* (Thessalonica 1996)

Ancient Sources

Amm. Marc.

Ammianus Marcellinus, with an English translation by J.C. Rolfe (Cambridge, Mass. and London 1982)

Anacreont.

'Anacreontea', in *Greek Lyric* II, with an English translation by D.A. Campbell (Cambridge, Mass. and London 1988)

Ant.Pal.

Epigrammatum Anthologia Palatina, vol. 1, ed. F. Dübner (Paris 1871)

Aristophanes

F.W. Hall and W.M. Geldart (eds.), *Aristophanis comoediae, I: Acharnenses, Equites, Nubes, Vespas, Pacem, Aves continens*, 2nd ed. (Oxford 1906), with reprints

Athenaeus

Athenaeus, *The Deipnosophists*, with an English translation by C. Burton Gulick (Cambridge, Mass. and London 1933), with reprints

Hippocrates, *VM*

Περί ἀρχαίης ἱητροικῆς in H. Kuehlewein (ed.), *Hippocratis opera omnia*, I (Leipzig 1894), 1-30